

# Improving Water-Related Food Production Systems in Caribbean Small Island Developing States (SIDS)



## A TRAINING MANUAL ON AQUACULTURE FOR CARIBBEAN SIDS

2020

CARIBBEAN  
WaterNet

Cap-Net

  
UWI  
ST. AUGUSTINE  
CAMPUS  
FACULTY OF FOOD  
AND AGRICULTURE

 Global Water  
Partnership  
Caribbean

# A Training Manual on Aquaculture for Caribbean SIDS

The drafting of this training manual was coordinated by Caribbean WaterNet (Cap-Net UNDP), The Faculty of Food and Agriculture of The University of the West Indies (UWI) St. Augustine Campus in partnership with the Global Water Partnership-Caribbean (GWP-C).

The manual was written by Dr. Ryan S. Mohammed (MSc Programme in Biodiversity Conservation and Sustainable Development in the Caribbean, UWI St. Augustine). It was edited by Dr. Ronald Roopnarine (Faculty of Food and Agriculture, UWI St. Augustine & Caribbean WaterNet) and Gabrielle Lee Look (GWP-C).

Portions of text from this training manual may be reproduced for educational or non-commercial use without prior permission, provided that the source is acknowledged, with mention of the complete name of the Manual, and that the portions are not used in a misleading context. No use of this publication may be made for resale or other commercial purposes without prior written permission.

The training manual can be downloaded from the following websites:

[www.cap-net.org](http://www.cap-net.org)

[www.gwp-caribbean.org](http://www.gwp-caribbean.org)

[www.sta.uwi.edu/ffa](http://www.sta.uwi.edu/ffa)

© Published in 2020 by Caribbean WaterNet (Cap-Net UNDP), The Faculty of Food and Agriculture of The University of the West Indies (UWI), St. Augustine Campus and the Global Water Partnership-Caribbean (GWP-C).

Photo Images: Global Water Partnership-Caribbean (GWP-C), Dr. Ryan S. Mohammed, Pixabay and Pexels.



# Foreword

Caribbean WaterNet (Cap-Net UNDP), The Faculty of Food and Agriculture of The University of the West Indies (UWI) St. Augustine Campus and the Global Water Partnership-Caribbean (GWP-C), have developed this Training Manual on Aquaculture for Caribbean Small Island Developing States (SIDS), to build capacity for improving water-related food production systems in the Caribbean.

The author of this manual is Dr. Ryan S. Mohammed (MSc Programme in Biodiversity Conservation and Sustainable Development in the Caribbean, UWI St. Augustine). Input for the development of the training manual was provided by Dr. Ronald Roopnarine (Faculty of Food and Agriculture & Caribbean WaterNet). This knowledge product will be used as a training tool throughout the Caribbean and serves as both a participant handbook and facilitator's guide.

It is within the culture of citizens of Caribbean Islands to consume seafood. It is this culture that has led to wide diversification of seafood types and dishes. Our roadside and community 'Fish Fry' events are a staple event for several Caribbean Islands for our locals. Whether it's flying fish and mahi mahi grilling at Oistens in Barbados, Gros Islet Friday Night Street Party in St. Lucia, Gouyave in Grenada, steam fish in Port Royal, Jamaica, curry crab, callaloo and dumplings in Store Bay, Tobago or Bake and Shark in Maracas Beach, Trinidad, these islands have seafood consumption embedded within their souls. This has now become a spatial and temporal landmark on several tourism guides, which indicate days and times these 'Fish Fry' events occur.

However, it is this culture of consuming what seemed to be a never-ending supply of seafood, that has led to increased fishing efforts and simultaneous decreased catches and profits. Overfishing, challenges with inter-island management of fish stock, habitat loss, climate change and increased severity and frequency of adverse weather conditions, have all contributed to our dwindling seafood stocks.

# Foreword

Caribbean Small Island States import approximately 50% of all seafood consumed. On several occasions, these items arrive as a processed product either canned, dried, salted or frozen. This is not sustainable for the Caribbean, as our food security and food sovereignty is in jeopardy. This is where sustainable aquaculture with sound green implementation, can promote our future place in the Blue Economy. Jamaica, St. Lucia and Trinidad and Tobago have had some limited successes with aquaculture, but this focused mainly on either foreign shrimp or tilapia.

The following modules seek to provide the initial stages of information for the Caribbean Aquaculturist to not only start and operate a successful facility, but also build an aquaculture sector within Caribbean SIDS. The sectors for each island would be different as conditions, customs and resources would vary island to island. This manual seeks to provide information, guidance and options for the Caribbean Aquaculturist.

‘Give a man a fish, fed him for a day,  
‘Teach him to fish, fed him until the fish runs out’  
‘Help him implement sustainable aquaculture, he will feed his nation’

**Dr. Ryan S. Mohammed**  
Lecturer  
**MSc Programme in  
Biodiversity Conservation and  
Sustainable Development in the  
Caribbean, The University of the  
West Indies (UWI)  
St. Augustine**



**Dr. Ronald Roopnarine**  
Lecturer  
**Faculty of Food and  
Agriculture, The University  
of the West Indies (UWI)  
St. Augustine**  
&  
Network Manager  
**Caribbean WaterNet  
(Cap-Net UNDP)**



**Simone Lewis**  
Regional Coordinator  
**Global Water  
Partnership-Caribbean  
(GWP-C)**



# Table of Contents

<b>FOREWORD</b> .....	III - IV
<b>Module 1: Choice of Species</b> .....	1
<b>Module 2: System Selection</b> .....	10
<b>Module 3: Site Selection</b> .....	24
<b>Module 4: Hatchery Design and Management</b> .....	30
<b>Module 5: Grow-Out Management</b> .....	40
<b>Module 6: Stock Harvesting and Processing</b> .....	48
<b>Module 7: Water Budgeting and Production Waste Management</b> .....	58
<b>Module 8: Budgeting and Cash Flow Management</b> .....	64
<b>CONCLUSION</b> .....	70

# MODULE 1

---

## Choice of Species

### Goal

The purpose of this module is to provide the trainees with the information to better understand the criteria used for species selection for culture. Additionally, candidates should also be aware of what are the options available in the Caribbean for culture.

### Learning Objectives

**At the end of this module, trainees are expected to:**

- ▶ Be aware of multiple species, local and exotic options for Caribbean aquaculture.
- ▶ Be able to select possible species for culture, based on the criteria outlined.



# Introduction

The most probable candidates for an intensive, commercial aquatic animal husbandry industry and aquatic plants are considered. The flora and fauna cultivated must be amenable to intensive management in high-density confinements, such as those now being engineered for high-yield aquaculture. Attributes considered are discussed in the context of the various aquacultural ecosystems in which the specific biotype is expected to achieve satisfactory growth and survival. Correlative with bionomic criteria, economic requirements are posed and evaluated in an effort to define a socially and financially profitable agribusiness system. Investment requirements and operating costs are considered in terms of expected returns.

However, since production alone is insufficient to sustain an enterprise – i.e. the product must be sold – production costs must be judged against market values. Therefore, ultimate use or consumer acceptance criteria is incorporated into the list of essential requirements for a candidate species for aquafarming. Typically, tilapia and carp have been shown to be the model species for inland freshwater aquaculture. Here we demonstrate the criteria for choice of species, in relation to water restrictions and availability of local species.

The choices will be divided into the following categories:

- a. Marine
- b. Freshwater
- c. Brackish water

## What is Aquaculture?

Aquaculture, also known as aquafarming, is the farming of organisms in aquatic medium including fish, crustaceans, molluscs, aquatic plants, algae. Aquaculture ranges from freshwater to saltwater populations under controlled conditions, and can be compared to commercial fishing which is the harvesting of wild fish.

## Criteria for Species Selection

The choice of culture species is in more ways than one, closely linked to the objectives of the development and therefore the strategy/approach to be used to achieve set goals. Not all aquatic fauna are suitable for aquaculture. By the same token, some cultivable species are more appropriate for large-scale commercial aquaculture, rather than for small-scale operations, as exemplified by the high-value shrimps, the production of which can hardly be undertaken profitably on a small scale. Also, some species are best cultured using specific types of enclosures; for example, penaeid shrimps are best cultured in fish ponds rather than in fish pens, and certain species are more acceptable in certain countries than in others.

The choice of species for culture depends on a number of factors including the availability of suitable sites for culture, the biological characteristics of the indigenous or introduced / exotic species, their suitability for culture, and their acceptability in the local or international markets, and the availability of technology and other requirements for their culture. More on these will be explained further in Modules 2 (Systems Selection) and Module 3 (Site Selection). (Adapted from Baluyut, 1989).

The following criteria can be used for evaluating the suitability of a species for culture (derived from Huet and Timmermans, 1972):

- (i) It must withstand the climate of the region in which it will be raised. Thus, the rearing of cold-water fish like salmonids and trout is limited to temperate regions or mountain areas of tropical countries, because they cannot tolerate warm water with its low oxygen content.
- (ii) Its rate of growth must be sufficiently high. Small species even if they reproduce well in ponds and accept formulated diets, are not the most suitable for rearing. Also, the best culture species are those which are low in the food chain, e.g. plankton feeders, herbivores, and detritivores. Their culture is also least expensive, even on an intensive scale, because they do not need to be given diets which have a high content of animal protein.



## Module 1: Choice of Species

(iii) It must be able to reproduce successfully under culture conditions. Species for culture should be able to reproduce in captivity/confinement without needing special conditions that have to be fulfilled, and which give high returns on eggs and fry. Although it is possible to rear species whose reproduction in confinement is not possible at all (e.g. some carps) or whose reproduction under hatchery conditions has not yet been possible on a commercial scale (e.g. milkfish in the Philippines), the sustainability of the grow-out operations is hampered by the seasonal unavailability of wild fry for stocking in fish pens and/or fish ponds.

(iv) It must accept and thrive on abundant and cheap artificial food. Culture species which feed on cheap artificial feeds and give low feed conversion ratios (FCRs), also tend to give very good production rates, thus bringing in better financial returns.

(v) It must be acceptable to the consumer. Even if all the foregoing criteria are met by a candidate species, it is not worth culturing if there is no market for it. It is possible though, to promote acceptability of or encourage consumption of a particular species to ensure that it will eventually sell in the market, e.g. tilapia in the Philippines prior to the introduction of the bigger-sized, lighter coloured *Oreochromis niloticus* (previously *Sarotherodon niloticus* or Silver or Nile Tilapia) in the early 1970s.

(vi) It should support a high population density in ponds or tanks. Social and gregarious species which can grow well to marketable size, even under high density conditions in ponds or tanks (e.g. tilapia) are preferable to those which can be grown together in dense numbers only up to a certain age beyond which they eat each other (e.g. pike).

(vii) It must be disease-resistant. Reared fish must be resistant to disease and accept handling and transport without much difficulty. Tilapia is an ideal species for culture because of its high resistance to disease even in highly intensive culture systems.



## Module 1: Choice of Species

A wide variety of fish and aquatic resources is cultured in freshwater, brackish water, and marine environments world-wide using different methods. Rabanal (1988) estimates that there are close to 50 species of freshwater, brackish water, and marine finfish species; about 13 crustacean species, 13 molluscan species, 5 seaweed species, and 5 economic aquatic vertebrates (frogs and other amphibians and turtles and other reptiles) cultivated in Southeast Asia. Climatic conditions in Southeast Asia and African continent and tropical South America are comparable to the Caribbean.

Liao (1988) lists some 25 major finfish species, 18 molluscan species, 2 reptile species, 2 amphibian species, and 4 seaweed species, as the principal species cultured in Asia (**Table 1**). To the list could be added the crustaceans consisting of the brackish water/marine penaeid shrimps (mainly *Penaeus monodon*, *P. semisulcatus*, *P. japonicus*, *P. orientalis*, *P. merguensis* and *Metapenaeus ensis*) and the freshwater prawn of the genus *Macrobrachium*; the seaweeds *Eucheuma*, *Laminaria*, and *Porphyra*; and marine finfishes like sea bass and groupers (Baluyut, 1989a).

In Africa, the predominant species are the tilapias, carps, mullets, sea bass, and catfishes; in addition, some salmonids, miscellaneous freshwater fish, molluscs, and crustaceans are also cultured. Latin America grows miscellaneous exotic fish and marine shrimps, molluscs, and salmonids. Successful experiments on the artificial reproduction and pond culture of indigenous finfishes of the genus *Colossoma* and *Piaractus* (locally known as "tambaqui" and "pirapitinga" in Brazil, "cachama" and "morocoto" in Venezuela, "gamitama" and "parco" in Peru, and "cachama negra" and "cachama blanco" in Colombia) also give promise of increased yields (Saint-Paul, 1989); in the Mediterranean region, salmonids are the prime fish and carps are secondary fish. In the Pacific, tilapia, milkfish, catfish, salmonids, marine and freshwater crustaceans, molluscs (including giant clams and pearl oysters), and seaweeds are cultured but mostly on a pilot / experimental scale (ADCP, 1989).



## Module 1: Choice of Species

**Table 1:** Principal aquaculture species in Asia. Asia is chosen as the species, as they are comparable to the Caribbean Tropics.

\*Culture System: EX = experimental, E = extensive, S= semi-intensive, I = intensive

\*\*Environment: F = freshwater, B = brackish water, S= saltwater

Common Name	Scientific Name	Culture System*	Environment**
FINFISHES			
Milkfish	<i>Chanos chanos</i>	E, S, I	F, B, S
Freshwater eel	<i>Anguilla japonica</i>	EX, E, I	F
	<i>Anguilla spp.</i>		
Grey mullet	<i>Mugil cephalus</i>	EX, E, I	F, B, S
Cockup	<i>Lates calcarifer</i>	EX	F
Grouper	<i>Epinephelus spp.</i>	EX	S
Porgy	<i>Mylio macrocephalus</i>	EX	S
	<i>Mylio spp.</i>		
Red porgy	<i>Chrysophry major</i>	S, I	S
Black porgy	<i>Acanthopagrus schlegeli</i>	S	B, S
Tilapia	<i>Oreochromis mossambicus</i>	SI	F, S
	<i>O. nilotica</i>	E, SI	F, S
	<i>Tilapia zillii</i>	S	F
	<i>O. aureus</i>	S	F
	<i>O. mossambicus x O. niloticus</i>	S	F
	<i>O. niloticus x O. aureus</i>	S	F
	<i>Oreochromis spp.</i>	S, I	F, B, S
Sweet fish, ayu	<i>Plecoglossus altivelis</i>	I	F
Common carp	<i>Cyprinus carpio</i>	E, S	F
Goldfish (wild)	<i>Carassius auratus</i>	E, S	F
Crucian carp	<i>Carassius carassius</i>	E, S	F
Puntius carp	<i>Puntius gonionotus</i>	E, S	F
	<i>Puntius spp.</i>		
Rohu	<i>Labeo rohita</i>	EX, S	F
Mrigal	<i>Cirrhina mrigala</i>	EX, S	F
Bottom carp	<i>Cirrhina molitorella</i>	E, S	F
Catla	<i>Catla catla</i>	EX, S	F
Grass carp	<i>Ctenopharyngodon idellus</i>	E, S	F
Black or snail carp	<i>Mylopharyngodon piceus</i>	E, S	F
Silver carp	<i>Hypophthalmichthys molitrix</i>	EX, E, S	F
Bighead carp	<i>Aristichthys nobilis</i>	EX, E, S	F
Nilem	<i>Osteochilus hasselti</i>	EX, E	F
Walking catfish	<i>Clarias batrachus</i>	E, S	F
	<i>Clarias spp.</i>		

## Module 1: Choice of Species

**Table 1:** Principal aquaculture species in Asia. Asia is chosen as the species, as they are comparable to the Caribbean Tropics.

\*Culture System: EX = experimental, E = extensive, S= semi-intensive, I = intensive

\*\*Environment: F = freshwater, B = brackish water, S= saltwater

Common Name	Scientific Name	Culture System*	Environment**
CRUSTACEANS			
White leg shrimp	<i>Litopenaeus vannamei</i> , formerly <i>Penaeus vannamei</i>	E, S	S
Giant tiger prawn, Asian tiger shrimp, Black tiger shrimp,	<i>Penaeus monodon</i>	E, S	B, S
Australian Red Claw Crayfish	<i>Cherax quadricarinatus</i>	E, S, I	F
Malaysian prawn	<i>Macrobrachium rosenbergii</i>	E, S	B, S
MOLLUSCS			
Japanese oyster	<i>Crassostrea gigas</i>	E, I	S
Hard clam	<i>Metrix lusoria</i>	I	S
Small abalone	<i>Haliotis diversicolor</i>	I	S
Corbiculas	<i>Corbicula fluminea</i>	E	F
	<i>C. formosa</i>	E	F
Purple clam	<i>Soletellina diphos</i>	E	S
Apple snail	<i>Ampullarius insularum</i>	S, I	F
Blood clam	<i>Tegillarca granosa</i>	S	S
	<i>Crassostrea malabonensis</i>	E	S
	<i>C. iredalei</i>	EX, E	S
	<i>C. palmipes</i>	S	S
	<i>C. cuculata</i>	EX, S	S
	<i>C. lugubris</i>	E	S
	<i>C. belcheri</i>	E	S
	<i>C. commercialis</i>	S	S
	<i>Metrix metrix</i>	EX, S	S
Cockle	<i>Andara granos</i>	E, S	S
Green sea mussel	<i>Mytilus smaragdinus</i>	EX, E, S	S
REPTILES			
Soft-shell turtle	<i>Trionyx sinensis</i>	I	F
Crocodile	<i>Crocodylus siamensis</i>	I	F
	<i>C. porosus</i>	I	F
AMPHIBIANS			
Bull frog	<i>Rana catesbiana</i>	S	F
Tiger frog	<i>Rana tigrina</i>	I	F
SEAWEEEDS			
Gracilaria	<i>Gracilaria spp.</i>	E	B, S
Nori	<i>Porphyra spp.</i>	E	S
Wakame	<i>Undaria pinnatifida</i>	E	S
Green laver	<i>Monostroma nitidum</i>	E	S

## Module 1: Choice of Species

Whilst this list is exhaustive, not all species here should be considered an option for the Caribbean. This is because care must be given to the potential for aquatic alien invasive species. This is particularly important for species such as the Snakehead fish. The snakeheads are members of the freshwater perciform fish family Channidae, native to parts of Africa and Asia. These elongated, predatory fish are distinguished by their long dorsal fins, large mouths, and shiny teeth. They breathe air with gills, which allows them to migrate short distances over land. They are particularly invasive in Florida (USA).

Of similar concern are the walking catfish (African and Asian species) and Australian red claw crayfish *Cherax quadricarinatus*, which is already considered an invasive species in Jamaica.

Species that have great potential for the Caribbean but might be unique to particular island preference are as follows (**seen in the Table 2**). However, these species meet the above listed criteria, particularly regarding production potential, as well as marketability.



## Module 1: Choice of Species

**Table 2: Potential aquaculture species for the Caribbean**

\*Environment: F = freshwater, B = brackish water, S = saltwater

Taxa	Common Name	Scientific Name	Environment*
Fish	Grey mullet	<i>Mugil cephalus</i>	F, B, S
Fish	American eel	<i>Anguilla rostrata</i>	F
Fish	Grey snapper	<i>Lutjanus gresius</i>	B, S
Fish	Dog snapper	<i>Lutjanus jocu</i>	B, S
Fish	Tilapia	<i>Oreochromis mossambicus</i>	F, S
Fish		<i>O. nilotica</i>	F, S
Fish		<i>O. aureus</i>	F
Fish		<i>O. mossambicus x O. niloticus</i>	F
Fish	Red tilapia hybrid	<i>O. niloticus x O. aureus</i>	F, B, S
Fish	Tri tri	<i>Sicydium sp.</i>	F, B
Fish	Crucian carp	<i>Carassius carassius</i>	F
Fish	Atipa, Cascaura, hassar	<i>Hoplosternum littorale</i>	F
Fish	Pacu	<i>Piaractus sp.</i>	F
Crustacean	Malaysian prawn	<i>Macrobrachium rosenbergii</i>	F, B
Crustacean	Common river prawn	<i>Macrobrachium crenulatum</i>	F, B
Crustacean	White leg shrimp	<i>Litopenaeus vannamei</i> , formerly <i>Penaeus vannamei</i>	S
Crustacean		Giant tiger prawn, Asian tiger shrimp, Black tiger shrimp,	<i>Penaeus monodon</i>
Crustacean	Australian Red Claw Crayfish	<i>Cherax quadricarinatus</i>	F
Mollusc	Black river conch	<i>Pomacea urceus</i>	F
Mollusc	Atlantic oyster	<i>Crassostrea virginica</i>	S
Mollusc	Caribbean mangrove oyster	<i>Crassostrea rhizophorae</i>	B, S
Reptile	Spectacled caiman	<i>Caiman crocodilus</i>	F, B
Plant	Sea moss, Irish moss	<i>Chondrus crispus</i>	S

### Goal

The purpose of this module is to provide trainees with the knowledge of multiple system options and the criteria used for choosing the system that is best suited for their situation.

### Learning Objectives

**At the end of this module, trainees are expected to:**

- ▶ Know the different types of production systems.
- ▶ Be able to determine the best system for their environment based on the criteria provided.



# Introduction

There are multiple systems available for commercial and domestic aquaculture. The choice of system is dependent on the outcome of cost benefit analysis and also availability of several input factors such as feed and water. This module will provide the options of systems, as well as demonstrate how to choose the best systems for the situation, such as location at hand.





### System Considerations

As aquaculture involves the application of certain methods and techniques in the breeding and rearing of fish and other aquatic species, the selection of a particular culture system will necessarily depend on whether or not the technology for such is available in the country or project area and if so, its level of complexity and/or transferability to the fish farmer beneficiaries.

In general, simple, low-cost, low-technology systems (as for tilapia culture) are easier to transfer to the end users and have greater chances of success as compared to more sophisticated/complicated and relatively high-technology systems like those involved in penaeid hatchery and farming, especially using intensive culture techniques.

Thus, if aquaculture is being considered as an alternative livelihood for displaced coastal fishing families, the preferred system is one that will require the use of simple techniques and low-cost production facilities, whose construction and operation may involve entire families or communities, e.g. seaweed and mollusc farming. On the other hand, more complex technologies which require higher capital and other inputs, as well as promise better profits, are usually adopted by medium to large-scale entrepreneurs who have the capability to engage the services of technical specialists in running their operations.

The magnitude of financial investment required to set-up, operate, and maintain an aquaculture operation, depends on the level of technology involved and the type of culture system adopted. In general, the investment requirement increases as a function of technology level and degree of complexity of the culture system, with extensive systems requiring the least capital investment and intensive systems needing the most.

Thus, as mentioned earlier, small-scale aquaculture development projects which involve simple production facilities (like rafts and stakes for mollusc culture and bamboos and ropes for seaweed farming) require minimal financial inputs. In contrast, highly intensive, highly complicated production systems, as those used for intensive shrimp grow-out operations, require large outlays not only for initial development but also for operation and maintenance.

The major cost items in aquaculture production, as in any other type of agriculture, include initial development and pre-operating costs including cost of land/site acquisition, production inputs (seed, feed, fertilizers, pesticides), and operating and maintenance costs (including cost of labour, power, supplies and materials), and miscellaneous expenses including harvesting and marketing costs. In general, production systems are either clear or green water systems. Clear water systems require additional housing protecting the entire system from direct sunlight, as this would promote algal growth. Algal growth in such systems, lead to clogging of filters and plumbing.

## Module 2: System Selection

Green water systems conversely require sunlight. These have less rigorous filtration and plumbing is of a thicker bore reducing the risk of clogging. Clear water systems allow for easier visual monitoring of fish behaviour, whereas green water systems (translucent), hinder visual inspection unless the fish are netted. Green water however, acts as a supplemental feed and also reduces ammonia concentrations. These systems work best with species that consume pelagic algae.

Where investment costs are high and land and labour are limited and costly (eg. Japan), the trend will be intensification to achieve maximum yields per unit area. Where land, labour and fish are inexpensive and feed is unavailable or costly (eg. Indonesia and Philippines), the trend is for extensive culture utilizing a larger pond area and natural food. Systems can either be extensive, semi-intensive or intensive as indicated in **Table 3**.

**Table 3: Criteria for farming system types**

Parameter	Extensive	Semi-Intensive	Intensive
Species Used	Monoculture or Polyculture	Monoculture	Monoculture
Stocking Rate	Moderate	Higher than extensive culture	Maximum
Engineering Design and Layout	May or may not be well laid-out	With provisions for effective water management	Very well engineered system with pumps and aerators to control water quality and quantity
	Very big ponds	Manageable-sized units (up to 2 ha each)	Small ponds, usually 0.5-1 ha each
	Ponds may or may not be fully cleaned	Fully cleaned ponds	Fully cleaned ponds
Fertilizer	Used to enhance natural productivity	Used regularly with lime	Not used
Pesticides	Not used	Used regularly for prophylaxis	Used regularly for prophylaxis
Food and Feeding Regimen	None	Regular feeding of high-quality feeds	Full feeding of high-quality feeds
		Depending on stocking density used, formulated feeds may be used partially or totally	
Cropping Frequency (crops/y)	2	2.5	2.5
Quality of Product	Good quality	Good quality	Good quality
	Culture species dominant but extraneous species may occur	Confined to culture species	Confined to culture species
	Variable sizes	Uniform sizes	Uniform sizes

# Module 2: System Selection

Ornamental species may also be considered, however if these are considered to be integrated within the food production component, care should be taken regarding chemical usage as some ornamental fish care products are not approved for use in fish for human consumption. The schematic below gives an idea of some production systems, options and classifications and suggested species (adapted from R. S. Mohammed, www.aqua-tt.org).

**Figure 1: Aquaculture Systems Choice (Source: aQua-TT, RSM)**

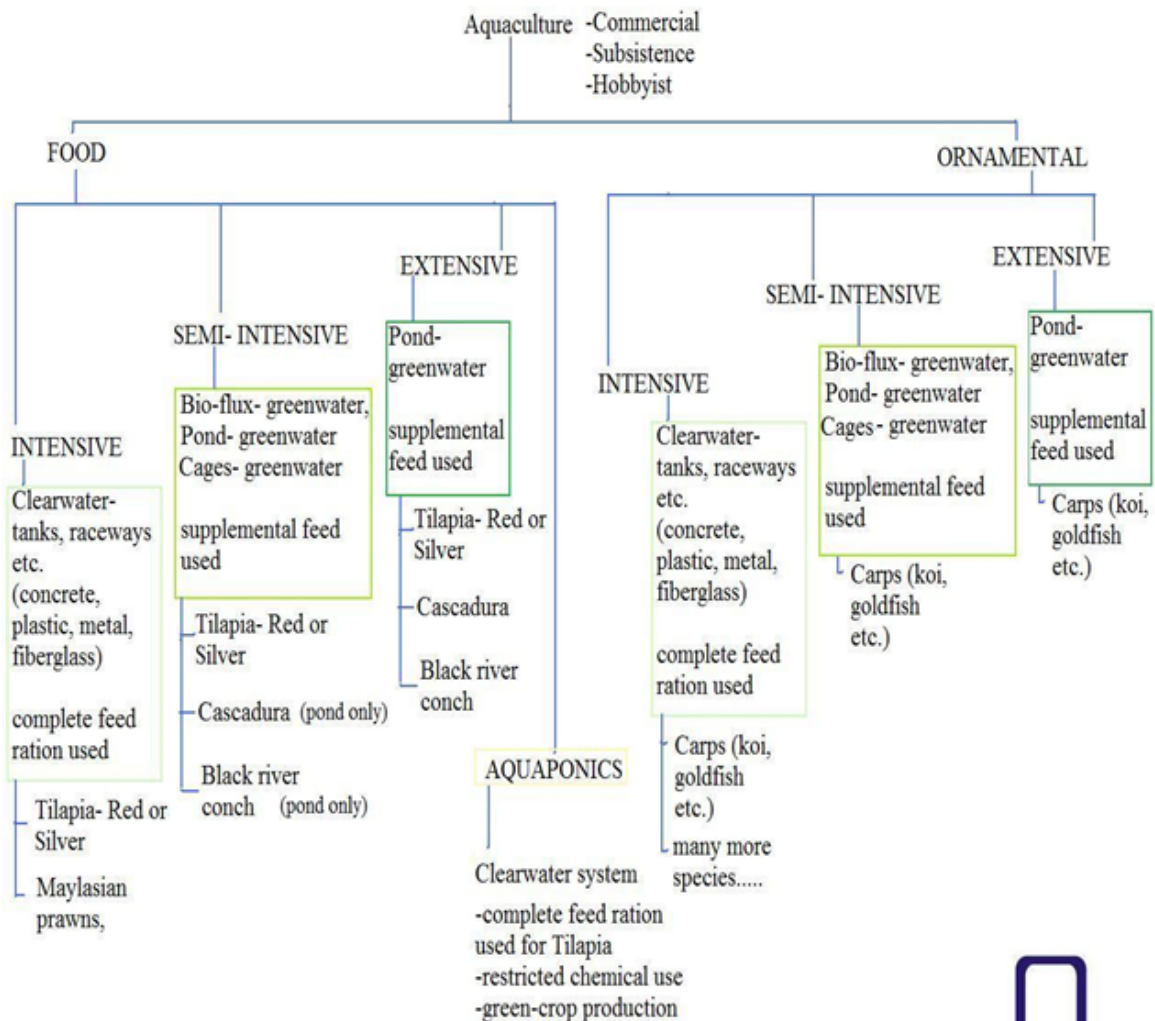

## Aquaculture Production System Choice Map



aquatt1@gmail.com

RSM July 2011

### Production System Options

The following system choices are available within the Caribbean:

#### Tank Systems

These are usually regularly shaped enclosures which may be about 1m in depth. The dimensions and shapes vary based on land availability. However, tanks typically can be quadrilaterals (square or rectangular), hexagonal, octagonal or circular. Prefabricated tanks are mostly plastics, reinforced plastics, wire framed with plastic liner or metal. These are circular and can come as a molded single unit or can be sheeted, which will require assembly on site. Circular and octagonal tanks have the advantage of continuous movement of fish usually in one direction which is suspected to aid in muscle development and also promote the well-being of the fish. They also promote better circulation and oxygenation of the water. Some tanks come with a conical base, creating a vortex for adequate removal of waste material. The disadvantage being these tanks require a greater real estate footprint, as unused spaces between tanks are inaccessible to the farmer. These are best suited for re-circulating green or clear water systems.

Quadrilateral tanks have the benefit of wall sharing, therefore more economically using real-estate. These are mostly built on site from concrete. Rectangular tanks offer the same benefit of wall sharing but are more efficient if the circulation is uni-directional with the inflow in the corner and the outflow at the diagonal, avoiding any looping eddy-currents. This will encourage proper filtration of the raceway. Tank systems can therefore be connected in series or parallel to allow for the use of a single water pump and filtration systems in modular clusters. Tank systems offer the additional advantage of water conservation, as water loss is reduced by limited disposal during cleaning of filters. Filters for such systems should have the capacity to hold 20% of the total volume of the entire system.

Regardless of the type of tank system, they all require a biological and mechanical filtration component. The mechanical filters remove suspended solids such as uneaten food and feces and the biological breaks down dissolved ammonia to less toxic nitrogenous waste compounds. The biological filter requires some aeration, as this is an aerobic system and stagnant water can lead to increased toxicity within the tanks.

Tank systems have another advantage of higher stocking density per unit area of fish but utilize higher infrastructure and operational cost, due to usage of electricity and more feed input. With this in mind, they are also more productive but also have higher risks associated, in comparison to pond systems. Harvesting is very easy as the entire enclosure can be drained and fish removed. **Figure 2** provides an overview and a scaled idea of real estate foot print for a commercial recirculating tank system.

**Figure 2:** Recirculating tank system. Arrows indicate unidirectional flow of water. Red lines represent the wastewater lines and green would be the filtered return water. Smaller red circles are the filter tanks and the green portion would be biological effluent grow box troughs with root crops to manage waste.

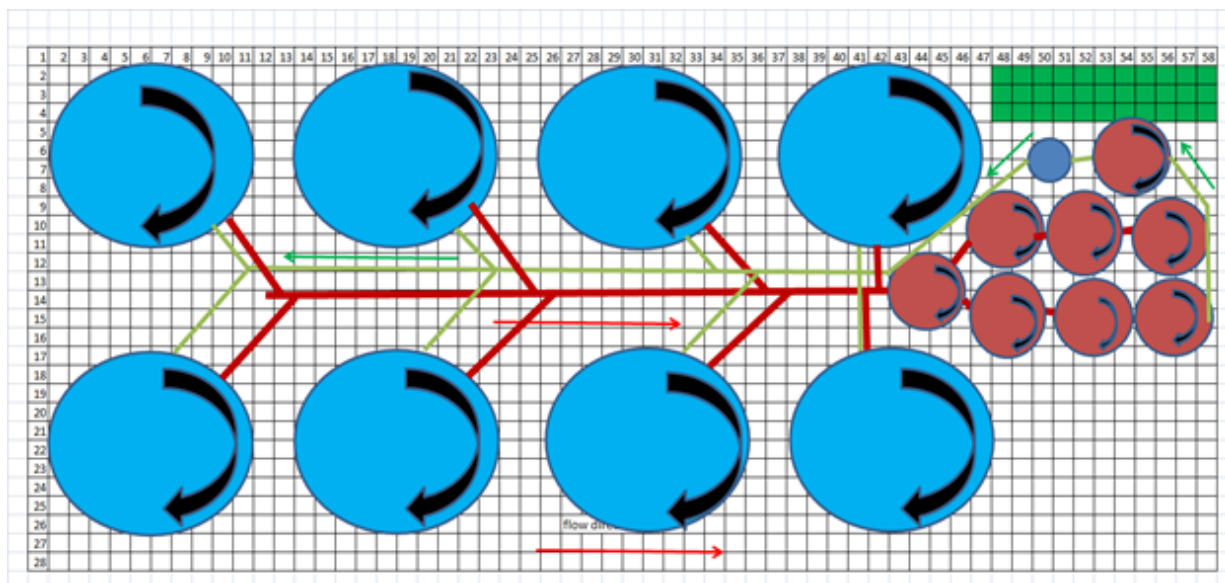

### Pond Systems

Ponds are typically no more than 1m within the ground with the dugout spoils used to create an additional embankment, to act as a flood barrier contingency. Pond systems are green water due to the algal content. This is favorable to some fish species but does not allow for easy monitoring of the stock. These systems offer the luxury of less management, input cost and risk but reduced profits.

Depending on the clay content and substrate type where the pond is located, water retention might be an issue. Sandy, rocky substrate within low water tables, give rise to water percolation and therefore water loss to the environment. In this scenario, ponds can be lined with clay to seal the base or a polyvinylchloride (PVC) pond liner is then deployed. The liners pose a challenge during harvesting as these become slippery. Unless ponds are drained completely, it is sometimes difficult to remove all stock from the enclosure. Some species such as catfish (eg. Atipa or Hassar) thrive better in an earthen pond system. **Figure 3** shows a cross sectional view of the earthen pond construction.

**Figure 3:** Cross sectional view of a pond construction and water plumbing system (adapted from Towers, 2015).

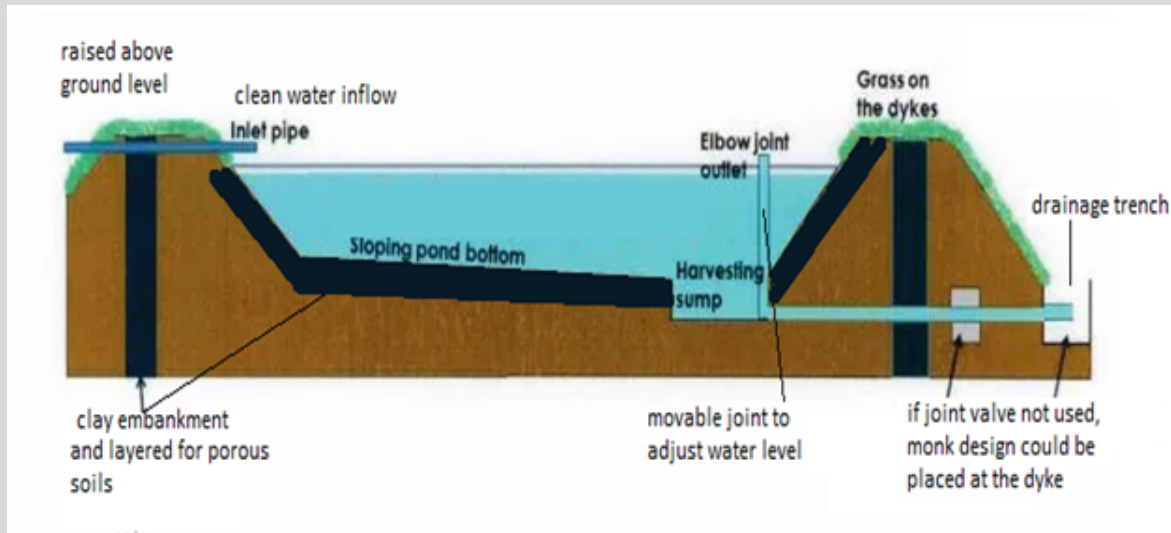

### Aquaponic Systems

Aquaponics is a system of cultivation that is starting to become more popular, both in commercial agricultural production and the smaller scale of the permaculture gardener and backyard growers. It is appealing to both, because it is a system that requires very little input in order to function well, and produces two types of food products, animal protein and plants. It is a system of aquaculture in which the waste produced by farmed fish or other aquatic creatures, supplies the nutrients for plants grown hydroponically, which in turn purify the water (adapted from Somerville et al. 2014).

Aquaponics uses a linked system of fish tanks and vegetables beds. The only inputs needed are food for the fish and a method to recirculate water around the system. Gravity can be used one way in some circumstances, but even then, a pump is required to complete the water flow cycle. The basic system involves pumping the water from the fish tank, complete with the droppings of the fish, into the vegetable beds. The plants use the nutrients from the droppings that are in the water, and in doing so filter the water so that it is clean enough to go back into the fish tank. There are three major forms of aquaponics systems: Media Filled Beds (MFB), Nutrient Film Technique (NFT) and Deep-Water Culture (DWC).

## Module 2: System Selection

Whichever system employed, there are many fish species that are suitable for aquaponics systems. These range from catfish and tilapia to carp and crustaceans.

Set-up costs can be minimized by using recycled containers for your fish enclosures (making sure they are thoroughly cleaned before stocking) and garden beds.

Commercial systems also use additional aeration in both the plant beds and fish tanks to reduce the likelihood of anoxic conditions, which could lead to sudden fish loss.

### a. Media Filled Beds (MFB)

The media bed aquaponics system is probably the easiest to set-up on a permaculture plot. It consists of garden beds filled with small porous rocks such as clay pellets. The vegetables are planted within this media. Water from the fish tank is either pumped or drained via gravity, depending on the specifics of your site, into the beds so that the plants can access the nutrients. The porous nature of the pellets allows them to hold water for longer, for more efficient nutrient uptake, and to remain aerated. The rocks also serve to filter out biological organisms such as parasites to prevent them going back into the fishes' water, as well as any solid material (plants take up nutrients in a dissolved, soluble form. Solids are not directly utilized. To avoid contamination of the water, a clarifier chamber is used to allow for suspended solids to settle. The clean water drains

into a container below the garden bed, and is then pumped back into the fish tank.

The garden bed can either have a continuous flow of water moving through it or is alternately flooded and drained, using a siphon to drain the water when it reaches saturation point. The media bed system can be used on a small or large scale and provides good plant support. The major disadvantage is that the rocks used to fill the beds can be quite an expensive initial cost. One must also monitor the pumps in case of bio-film blockage or media pellets wedging the pump. The garden bed must not be allowed to become waterlogged, as this can cause it to become anaerobic and affect plant growth and lead to root rotting.

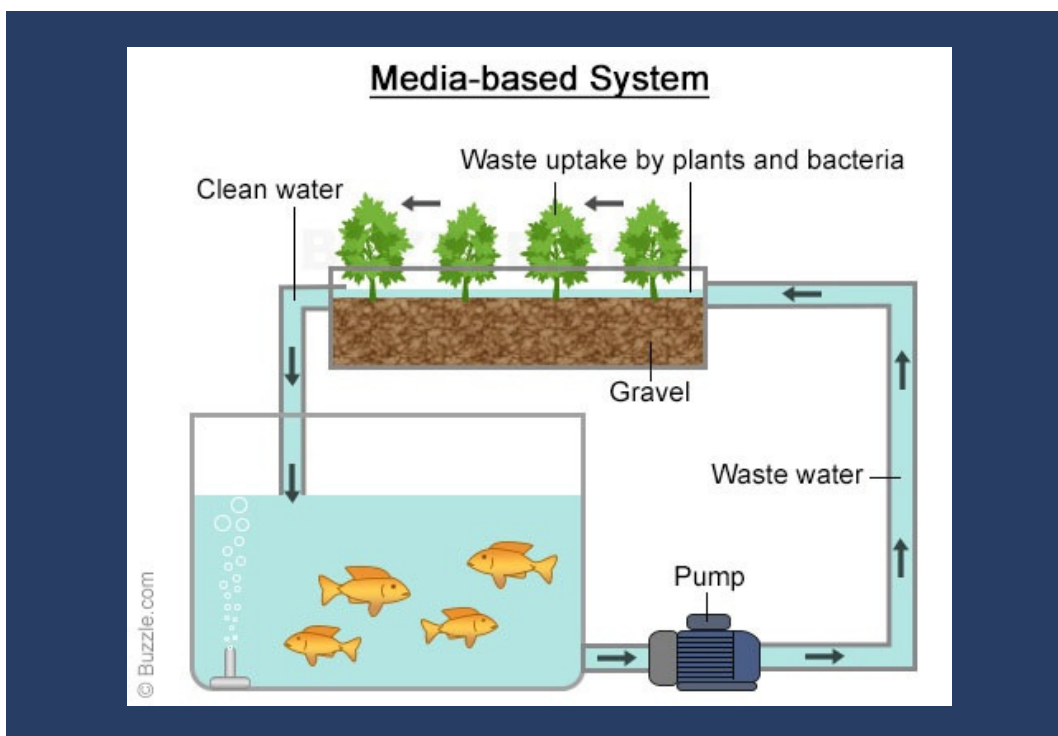

### b. Nutrient Film Technique (NFT)

The nutrient film technique involves siting a series of pipes adjacent to the fish tank and pumping water through them as a very thin film. The water moves slowly allowing plants, which have been placed in holes in the pipe, to access the nutrients within. When the water reaches the end of the pipes, it is pumped back to the fish tank. Because there is no solid material or surface of the water open to the air, extra filtration equipment is needed to clear the water of solid and biological waste before it is returned. However, the system is very efficient in its water use (See Figure 4).

This system is probably best used in large-scale aquaponics systems, but has the disadvantage of being unable to support larger, heavy plants, such as tomatoes and cucumbers, which can be utilized in the media bed system. It is primarily used to cultivate leafy green salads and herbs, which have small root systems and are relatively lightweight.

Figure 4: NFT generic system (sourced from Adhikari et al, 2020)

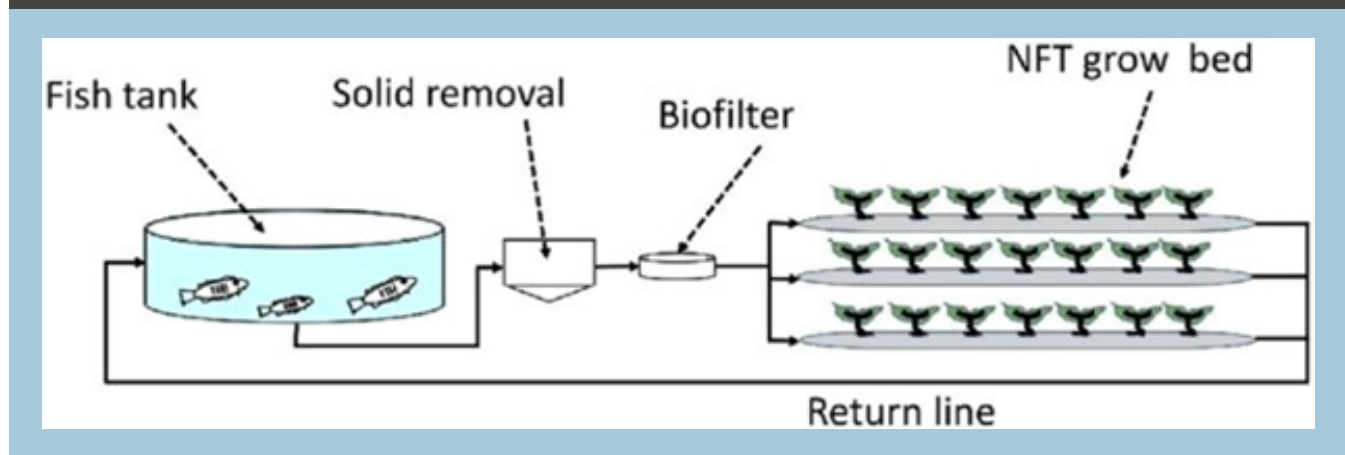

### c. Deep Water Culture (DWC)

The deep water culture system is sometimes referred to as the deep flow system, and involves siting the plants on rafts through which their roots protrude and hang in the nutrient-rich water from the fish tank. The water must be filtered of any solid waste before reaching the plants to avoid roots becoming clogged by suspended particles.

The equipment required is minimal and can be sourced cheaply. While commercial operations often use specially constructed channels to hold many rafts (allowing for ease of harvest, as well as capacity for higher yields) the system can easily be used in permaculture gardens and backyard systems. The raft is floated on water filled beds about 30cm deep. This system has the advantage of a more stable environment for both the plants and the fish. Fish can be kept in a production tank and water pumped to the plant grow-out beds. The system does not experience fluctuations in pH or temperature.



## Module 2: System Selection

A small-scaled modified version of this can be a simple Styrofoam container with a perforated base in which the plants are grown. The container is floated on the surface of the fish tank, with the filtration system attached. One needs to ensure the tank is not stocked with fish species that are voracious plant eaters, to avoid root destruction. The US Virgin Islands (UVI) system (Racocy, 2004) (**Figure 5**) is possibly one of the most famous working models of DWC that was developed in the Caribbean. **Figure 4** shows an overview of the farm layout.

**Figure 5: Racocy System, UVI, overview (2004)**

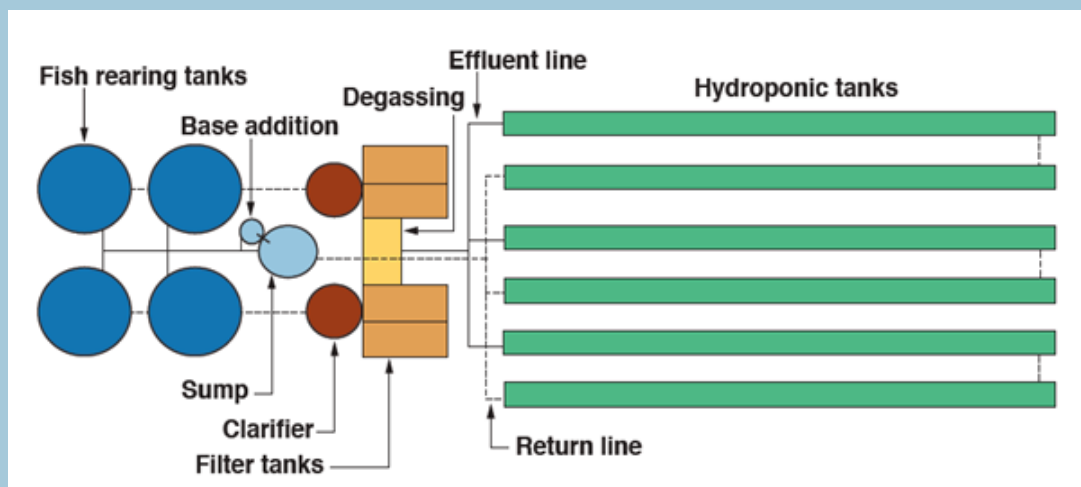

### Cage Culture (marine and freshwater)

Cage culture is an aquaculture production system where fish are held in floating net pens. Cage culture of fish utilizes existing water resources but encloses the fish in a cage or basket, which allows water to pass freely between the fish and the pond permitting water and gaseous exchange, as well as fecal waste.

Many landowners who are interested in aquaculture may not have the financial and physical resources or the practical experience to start a large-scale aquaculture operation. Growing fish in cages can be a means for landowners with existing ponds to produce fish for supplemental income and to gain experience in aquaculture. Cage culture is an intensive form of aquaculture that has its own set of advantages and disadvantages that should be carefully considered before making an investment. (adapted from Cline 2019). Size of mesh is dependent on the size of the fish being housed (See **Table 4, Figure 6** adapted from FAO, 1985).

**Table 4:** Mesh size in relation to size of fish

Size of Fish	Mesh Size
0.5 cm	1–2 cm
1 cm	5–10 cm
2 cm	20–30 cm
4 cm	> 30 cm

**Figure 6:** Suspended mesh design (adapted from FAO, 1985)

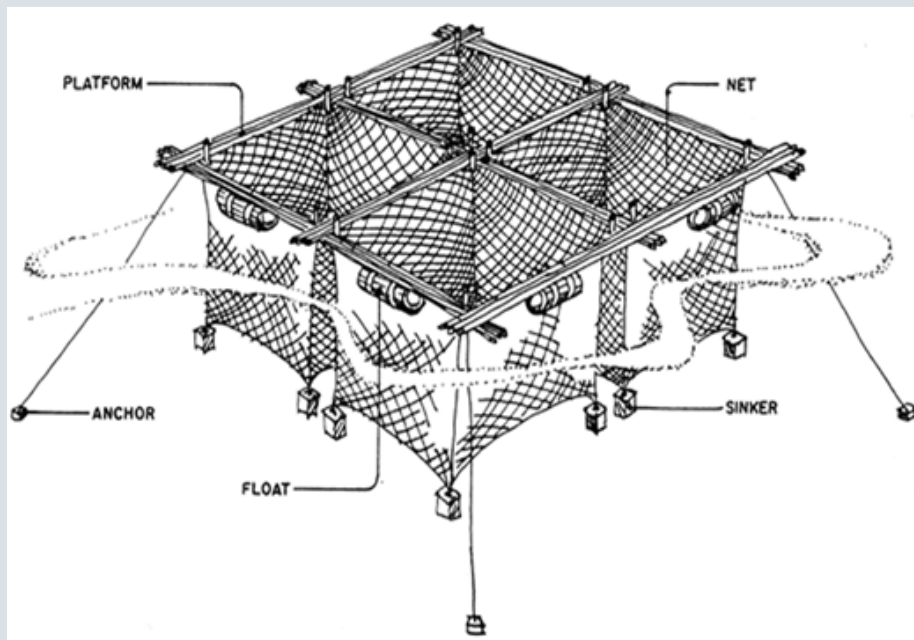

### Advantages of cage culture include:

- a. Many water resources can potentially be used, including ponds, lakes, strip pits, rivers, and streams.
- b. Cage culture requires a relatively small financial investment.
- c. Feeding, sampling, observation, and harvesting are all comparatively simple.
- d. The pond or water resource can still be used for other activities like stock watering or recreational fishing.

### Disadvantages include:

- a. The fish are crowded in cages, and there is a relatively high incidence of disease that can spread rapidly.
- b. There can be localized poor water quality, such as low dissolved oxygen, in and around cages.
- c. Caged fish do not have access to natural food, so a nutritionally complete diet is required.
- d. Cages can be attractive to predators, vandals, and poachers.

### Racks and Spats

Racks and spats are systems that target marine aquaculture of molluscan shellfish, such as bivalves which include mussels, oysters and clams. Local materials such as bamboo poles are used in many Caribbean regions for this.

The bamboo racks are built in areas where the water depth is 2-3 m. Nylon strings are hung from the racks with cultch separated by 15-cm spacers along the string. Bamboo spacers were originally used, but were replaced with old drip irrigation tubing which is available in large quantities, can be reused, and is durable and inexpensive. Racks can accommodate some 200 to 400 strings, with eight cultch pieces on each **(Figure 7)**.

To control the fouling of the spat by other organisms, such as barnacles, colonial ascidinas, and encrusting algae, the oysters must be "exposed" to the air every 2 weeks for 4 - 6 hours. This kills the organisms that have attached themselves to the cultch and are competing with the oysters for food. This is essential to produce a good yield of quality oysters. The strings are hung over a single upper beam, which causes less damage than the previous method of laying out the strings on rafts.

Figure 7: Oyster spats suspended (adapted from FAO 1985)

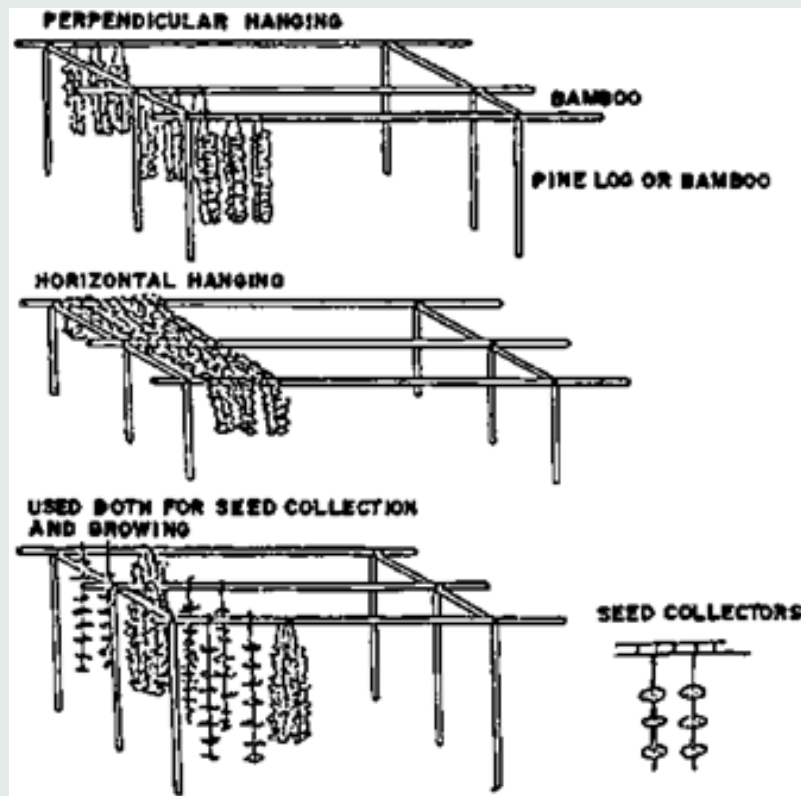

### Goal

The purpose of this module is to provide trainees with information to choose sites best suited for aquaculture facilities based on several criteria and type of system.

### Learning Objectives

**At the end of this module, trainees are expected to:**

- Know the criteria used for choosing a site for aquaculture facility.
- Be able to decide on the type of facility based on the species and space available.



# Introduction

This is equally important to System Selection and scenarios may arise where the site is not chosen but has to be adapted for production. In this module, the process of selecting the site given multiple criteria, will be elaborated in keeping with water and resource management. We will also consider extremes of weather, as well as water and waste management.

The ecosystem approach to aquaculture provides the conceptual guideline for spatial planning and management. The benefits from spatial planning and management are numerous and include higher productivity and returns for investors, and more effective mitigation of environmental, economic and social risks need to be considered in the processes and steps for spatial planning for aquaculture zoning, site selection and area management.

Integral topics that should be considered are: (i) accessibility; (ii) bio-security zoning; (iii) aquaculture certification and zonal management; (iv) an overview of key tools and models that can be used to facilitate and inform the spatial planning process. **Figure 8** summarizes the preceding criteria for site selection.

## Site Selection

Success or failure of any aquaculture venture largely depends on the suitable site selection for its commissioning. In choosing a site, several factors other than the physical aspect of the site are to be considered. The factors to be considered cut through various disciplines and range from socio-economic aspects of aquaculture to all the physico-chemical and biological conditions of the environment. This consideration should be with reference to the specific culture system and species chosen as viewed from the objective of the venture. The objectives of aquaculture could be to produce wholesome nutritious food for local consumption via small-scale or larger commercial systems. Alternately the objective could be for the production of high-cost fish or shrimps for export and earning foreign exchange for the countries concerned. (adapted from Baluyut, 1989).

As it would be obvious, no venture can sustain unless it is profitable. Site selection is the process by which various factors indicated are considered to enable one to decide on the right site for a specific culture system or alternately, to decide on a culture system suiting the site available.

Several types of water bodies can be used for fish culture - the choice of a specific body would depend on the objective of the investors and also the type of aquaculture. Among the sites suitable for inland and marine aquaculture could include: land-swamps, rivers, stream beds; coastal areas - bays, estuaries backwaters, lagoons, salt marshes and mangrove swamps; lakes, reservoirs and other water bodies, including irrigation tanks and canals. Terrestrial systems also have its own criteria as well.

The specific site to be chosen would be based on the requirement of the culture systems. Static water ponds are the most common, hence pond culture the most important system. Most of these are confined to freshwater areas, but brackish water ponds are also becoming more common. There is a variety of culture systems which can be developed in open waters - the stocking and management of open waters themselves being a major occupation, e.g. extensive stocking of man-made reservoirs and lakes.

In the larger freshwater bodies and coastal areas, cage and pen culture can be developed. Site selection for these culture systems has to be carefully done, based on the requirements of the species to be cultured and the structures to be erected for the culture. Here and in the culture systems where closed systems are used, the inputs required can be costly and management intensive. Thus, there can be gradation of culture, systems based on the input costs and management strategy employed, from extensive, through semi-intensive to intensive.

There are several aspects to be considered for the selection of site for a culture system, as would be evident by a scrutiny of the various factors which go into these considerations. The various aspects will be discussed in sequence during discussion under this subject. Both technical and non-technical aspects will have to be considered, which are:

### **I. Socio-economic, political and legal factor such as:**

- a. social and religious customs
- b. consumer preference
- c. nature of manpower (labour) - quality and quantity available
- d. transportation and communication facilities; i.e. infrastructure facilities
- e. accessibility and nearness to market
- f. costs and availability of construction materials.

While the acceptance or preference of the local community would be of prime interest in producing fish for local consumption, the acceptability of the target group to whom the fish are supplied, in some cases, even by export, is of major interest. But consideration of other socio-economic aspects such as:

- a. infrastructure facilities for post-harvest treatment of product including marketing.
- b. manpower quality and quantity, could be same, if the fish produced is for local (same province/country) consumption or export outside the country.
- c. legal permits must be considered regarding land use zoning for other agricultural practices, industrial regions, residential areas and forestry or wetland areas.

Similarly, relative merits or demerits of the specific site, with reference to availability and cost of materials and equipment for farm construction and subsequent needs for renewals in the farm structures and also for the maintenance of the farm, e.g. supplies of feed stuffs and fertilizers should also be considered.

### II. Climatic factors:

a. Sites that are located on leeward sides of islands are preferred, as these are less likely to be damaged by adverse weather conditions. However, with the increased storm activity in the Caribbean within the last decade, there is now a need to engineer, design and implement storm resilient infrastructure.

b. Conversely, a site should also be selected where there would still be access to sufficient rainfall for water storage in reservoirs and tanks.

### III. Major environmental factors:

**a. Topography and ground elevation:** Sites located in valleys might be prone to flooding which could lead to high losses being incurred. Conversely, sites located at higher elevations might have water scarcity issues if there is a dependency on publicly accessed water from the national grid. Preferably with average elevation that can be watered by ordinary high tides and drained by ordinary low tides; tidal fluctuation preferably moderate at 2-3 m. Sites where tidal fluctuation is large, say 4 m, are not suitable, because they would require very large, expensive dikes to prevent flooding during high tide. On the other hand, areas with slight tidal fluctuation, say 1 m or less, could not be drained or filled properly.

**b. Soil:** For pond-based systems, 70% and greater clay content is integral for water retention. Conversely sites with porous or rocky substrate might be better suited to utilize tank-based systems, as these would provide suitable foundation to support the high volume and weight of the water and the associated infrastructure. Preferably, clay-loam, or sandy-clay for water retention and suitability for diking; alkaline pH (7 and above) to prevent problems that result from acid-sulphate soils (e.g. poor fertilizer response; low natural food production and slow growth of culture species; probable fish kills).

#### **c. Water supply quality and volume:**

**i. chemical and biological features of water:** Good water quality is integral for aquaculture systems. Water with elevated concentrations of nitrogen, ammonia, phosphates and various heavy metals should be avoided. Steady supply of both fresh and brackish water in adequate quantities throughout the year; water supply should be pollution-free and with a pH of 7.8-8.5.

**ii. associated land-vegetation:** Sites located near natural vegetation are preferred for tank and pond-based systems. Sites near field-based crop production run the risk of fertilizer and pesticide contamination of groundwater. Aerial spraying of field crops could also lead to contamination of water. Pond systems are very susceptible to this risk, as they have a surface area to volume ratio. Preferably without big tree stumps and thick vegetation which entail large expense for clearing; areas near river banks and those at coastal shores exposed to wave action, require a buffer zone with substantial growths of mangrove. The presence of *Avicennia* indicates productive soil; nipa and trees with high tannin content indicate low pH.



## IV. Accessibility:

The site should be readily accessible by land or water transport and close to sources of inputs such as fry, feeds, fertilizers, and markets, fish ports, processing plants, and ice plants. The facility should be linked by communication facilities to major centres.

**Figure 8:** Summarizes these criteria for easier decision-making when choosing suitable site locations. Source: Assefa, 2018

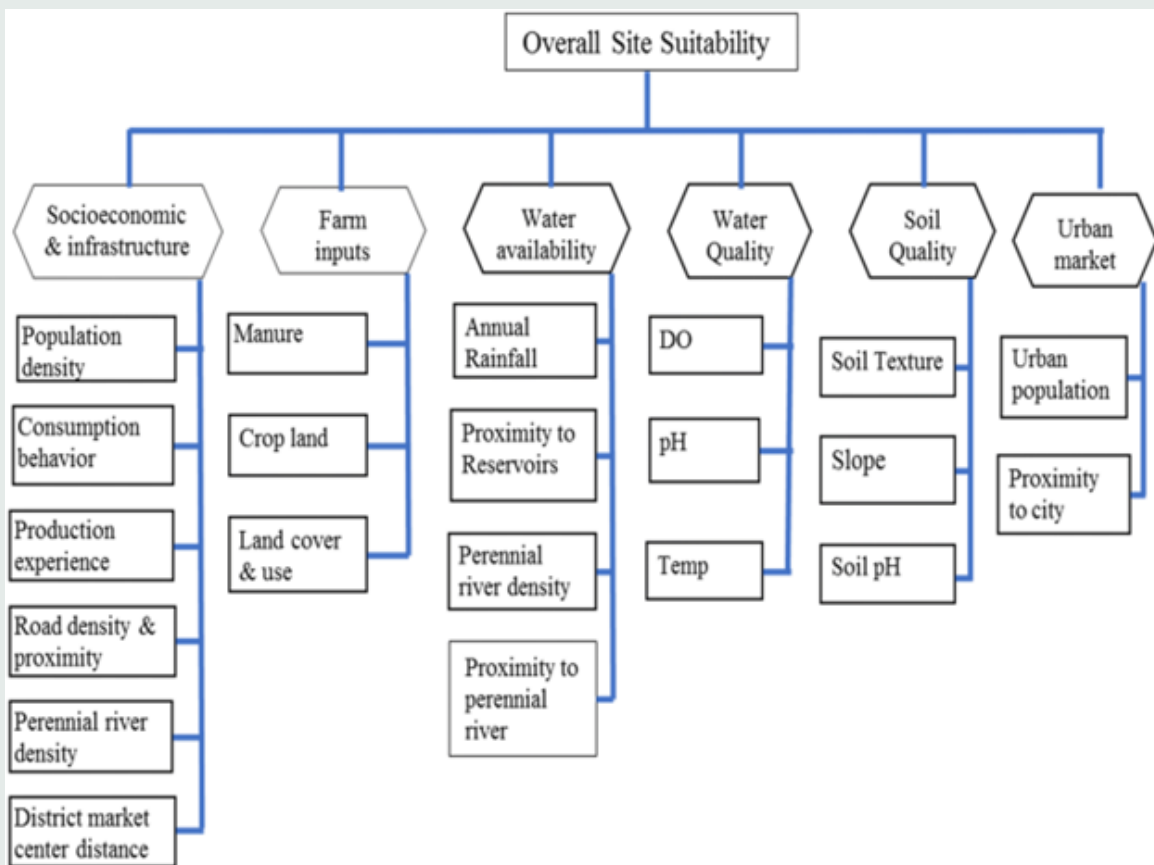

### Special Consideration for Marine Aquaculture

With aquaculture steadily expanding, the need for suitable space has been followed by the development of more efficient, cost-effective, and environmentally sustainable methodologies. Avoiding possible conflicts between the development of commercial aquaculture operations and the environmental impact in coastal areas, utilizing the offshore environment, offers the greatest potential for expansion of the industry in most regions throughout the world. Although currents and greater depths generally increase the assimilation capacity and energy of the offshore environment and offer many advantages for aquaculture, a number of challenges associated with developing any activity in the open ocean environment must be taken into consideration.

#### **When considering spat and rack systems, proposed sites must have the following:**

- i. Close proximity to adequate market demand for the product, as the best price is fetched fresh and alive eg. oysters and mussels. Tourist areas often provide higher prices and a higher demand for oysters.
- ii. The water quality must conform to official standards of safety (maximum of 14 fecal coliforms per 100 ml of water).
- iii. Protection from rough seas is of utmost importance for both rack and spat systems, as well as cage culture systems.
- iv. Access to hardwood poles and bamboo for the racks.



# MODULE 4

---

## Hatchery Design and Management

### Goal

The purpose of this module is to inform trainees about hatchery design and management. The trainees would have a better understanding of hatchery infrastructure.

### Learning Objectives

**At the end of this module, participants are expected to:**

- ▶ Know the infrastructure needed for a general hatchery.
- ▶ Be able to manage brood stock and juvenile fish.



# Introduction

Hatchery design and operations can be a separate procedure within the aquaculture sector. However, for small establishments where grow-out and hatchery services are on the same compound based on the requirements of the sector, hatcheries will be needed. The advancement of aquaculture has been bottlenecked many times due to the lack of seed, but once that bottleneck is overcome for a species, rapid growth has often followed. Culture of Chinese carp for example, is one of the oldest forms of aquaculture, but it was restricted to areas of China where seed could be collected from the wild. Its production remained restricted for thousands of years until the 1950s, when induced spawning techniques were developed. This allowed these valuable aquaculture species to become available worldwide.

The recent growth of marine fish culture has been due in part to being able to overcome the bottleneck of seed production. Gilthead seabream is a highly valued fish throughout the Mediterranean, whose culture was limited until hatchery techniques were improved. In the 1960s and 1970s, initial research was conducted regarding the reproduction of this species. The fish could reproduce successfully, but larval survival was less than 5%. Once advances in larval nutrition and other aspects of early life history were made, survival improved, and a commercial industry rapidly developed.

More recently, the Pangasius (an Asian catfish) is another example of the rapid growth possible, once hatchery techniques become established. In 2000, Vietnam produced limited quantities of Pangasius for domestic markets and little for export. But by 2009 – thanks to research on the artificial propagation of Pangasius – it was exporting 607,700 metric tons annually.

To increase seed supply, a number of factors have to be considered. Advances in fish hatchery management – particularly in the areas of brood management, induced spawning and larval rearing – have helped establish aquaculture for multiple species. (adapted from Meenakarn and Funge-Smith, 1998).



### Hatchery Design

Hatcheries are usually designed with a particular species in mind. Nonetheless, there are elements common to most hatcheries. It is imperative that good water quality is maintained, therefore having adequate water storage is essential.

Bio-security is also very important, having said this, it is common practice to maintain phytosanitary systems such foot baths at the entrance of hatcheries.

#### Facilities and equipment for a hatchery include:

1. Ponds or tanks for holding and rearing brood stocks
2. Spawning pond, tanks or hapas
3. Nursery pond, tanks or hapas
4. Conditioning pond/tank
5. Water supply system and storage tank
6. Aeration system
7. Pumps (for recirculatory egg incubation system)
8. Electricity supply and/or generator
9. Basins, buckets, containers
10. Seine nets, scoop nets, grading basket
11. Sensitive scale for weighing fry and fingerlings
12. Accessories for packing of fry and fingerlings

Hatcheries consist of multiple pond types based on the size of fish to be housed and purpose. These include (**Figure 9**):

1. Nursery pond: for growing/nursing fry to fingerlings
2. Brood stock pond: for rearing/holding the breeders for spawning
3. Sex-reversal pond: for sex-reversal of newly hatched fry
4. Conditioning pond: for holding fingerlings before transport
5. Grow-out pond: for growing fingerlings till harvest (to table-size)
6. Quarantine pond: for introducing new fish to the farm or for treatment purposes
7. Reservoir pond: for storing inlet water before use in the hatchery and nursery

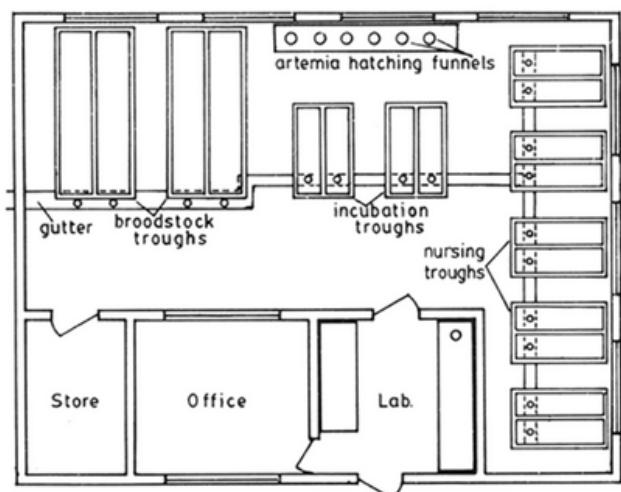

**Figure 9:** Hatchery design including some of the above facilities (FAO 1988)

### Brood Stock Management

The aim of brood stock management and breeding plans for hatcheries supplying fish for culture-based fisheries (CBF) is to consistently provide good quality (fit and healthy) juveniles suitable for stocking. Most species of tilapia and crayfish show some degree of sexual dimorphism (**Figure 10 and 11**). The quality of juveniles produced by hatcheries depends on a number of factors across the different production stages, from brood stock procurement to harvesting nursery ponds, and encompass factors related to the nutrition, health and genetics of stock, and good husbandry practices.

The most important of these relate to brood stock management. Poorly planned genetic management of brood stock and breeding, can result in declines in the quality of stock over a number of generations leading to, for example, reduced fecundity, hatch rates and growth rates, and an increase in the incidence of abnormalities and susceptibility to diseases.

**Figure 10:** Identification of sexual dimorphic feature of Tilapia.  
Source: <https://www.aquanet.com/sexing-tilapia>

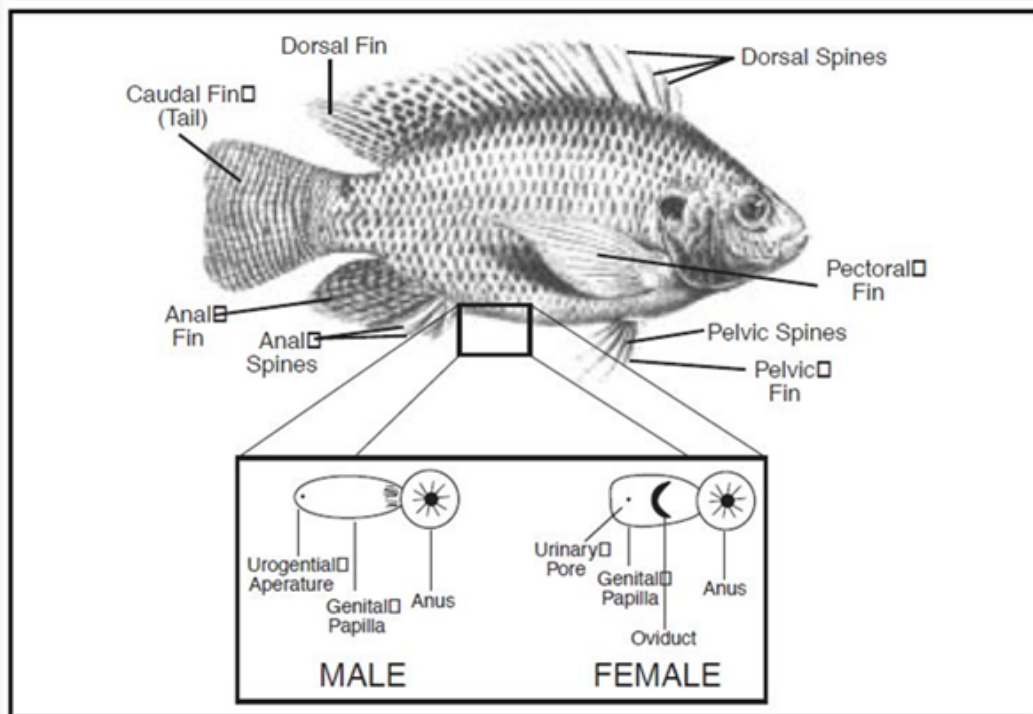

A major criticism of hatchery-bred fish relates to the perceived genetically inferior quality of released fish, which can interact with wild stocks leading to a shift or loss of genetic diversity and reduction in genetic fitness. Pedigree records are therefore imperative, regardless of species. Managing genetic aspects is critical to ensuring the long-term integrity and viability of a breeding program, and has important implications to the genetic integrity of receiving populations. Genetically sound management plans will vary according to the design of the breeding program ('closed' versus 'open' breeding systems) and requires a good understanding of the genetic structure of the species being bred.

Above all, brood stock management plans should aim to prevent loss of genetic diversity and minimise inbreeding within the population. This can be achieved in each season by; spawning an equal number of female and male fish (1:1 sex ratio); undertaking many spawnings; undertaking single-pair (one female and one male) matings only; retaining equal numbers of progeny from each spawning (family) as potential future brood stock; randomising brood stock choice for spawning to avoid trait selection; replacing at least 10% of the brood stock each year; and maintaining detailed and accurate breeding records. Other relevant factors for brood stock include the source, number, size (age) appearance and health of brood stock.

It is important to manage brood stock nutrition and pre-spawning conditioning, spawning and the immediate post-hatch stages (egg incubation, larviculture and post-larval husbandry). Brood stock nutrition and husbandry practices can affect gamete quality, which in turn, affect seedstock quality. A fish health and bio-security plan is required to manage the health of not only brood stock, but also larval and juvenile fish, which will eventually be released.

Having said this, adult brood stock fish take up a lot of space. The cost of feeding is high as these usually require feeds with higher protein concentrations.

### **Brood stock management covers three particular aspects of the rearing process:**

- (a) The selection of fish with desirable hereditary qualities typical of improved strains such as rapid growth potential, higher resistance to dissolved oxygen deficiency and adverse water quality, strong appetite, omnivorous feeding regime.
- (b) The selection of fish with well-developed sexual organs.
- (c) The rearing of these selected fish to produce healthy potential spawners, with dormant eggs well developed in the females.

## Module 4: Hatchery Design and Management

The selection of future breeders should take into account the general shape of the fish body, scale distribution, state of health and development of sexual organs. In particular:

- (1) the selected fish should be in good health
- (2) with no body wounds
- (3) no parasites
- (4) a typical scale distribution
- (5) no fin or body deformation
- (6) The body should possess the required shape and proportions, being neither too fat,  
too thin,
- (7) nor too thin

Figure 11: Identification of sexual dimorphic features of Australian Red Claw Crayfish

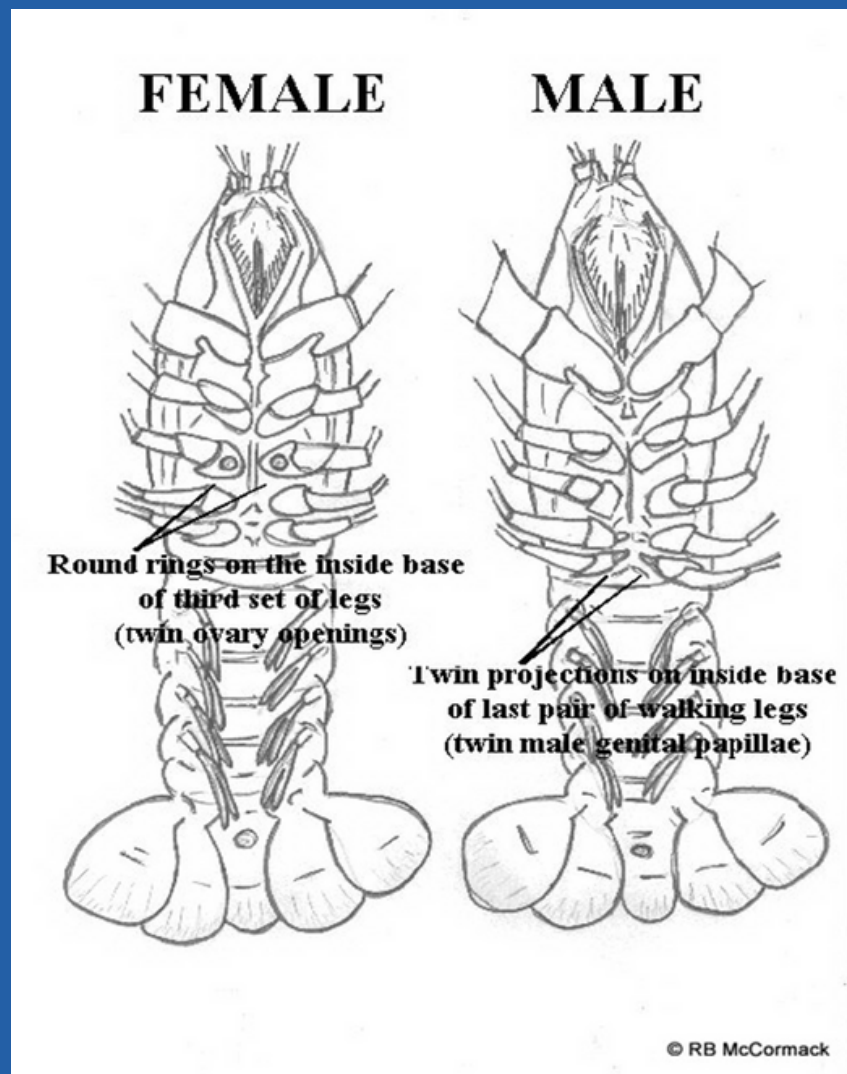



## Module 4: Hatchery Design and Management

Brood stock need to be handled very carefully. Injured fish can get an infection, and may die. Fish with eggs will not spawn if handled roughly. This can also lead to the demise of the fish. It is advised to avoid keeping fish too long in hapas (**Figure 12**), as there is not much space or oxygen and they will produce lots of waste.

Fish kept too long in hapas become stressed and can die in the enclosure, during transport or maybe even after they are stocked in the pond. **Some important tips for transporting fish include:**

- tank should be completely full of water so the fish do not get injured. This will avoid high turbulence slushing of water.
- putting a hapa in the transport tank can help removal of the fish out, without stress.
- the water should be the same temperature or slightly cooler than their pond.
- bubbling oxygen slowly through the water will avoid suffocation. If this is not possible, large plastic bags sealed with pressured oxygen inside will suffice.
- Do not overstock transport bags and enclosures.

Figure 12: Hapas for holding breeding adults. Source: FAO 2001

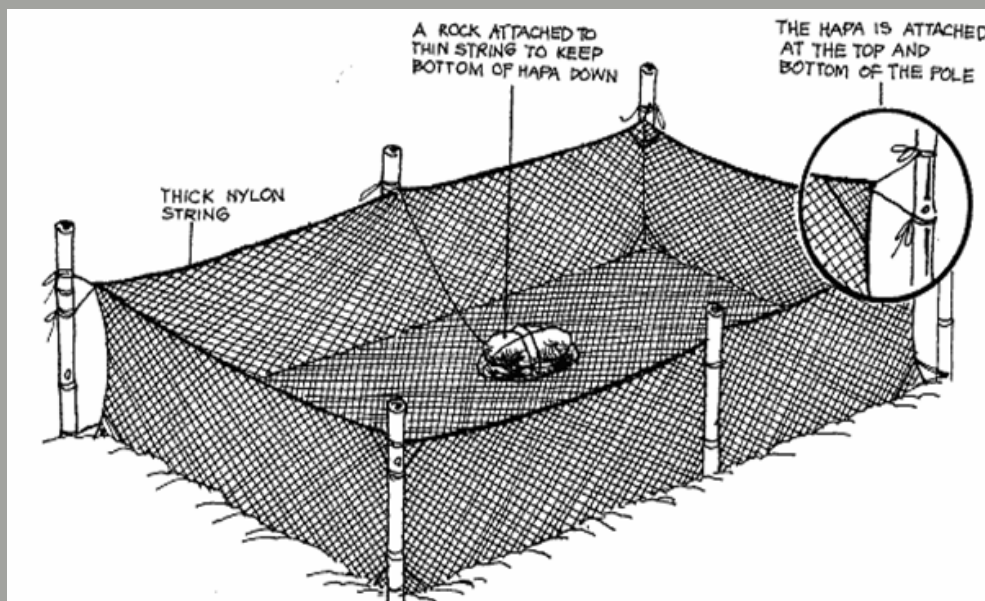

### Fry, Fingerling and Juvenile Production

#### Ponds Production

Fry rearing ponds, also called nursery ponds, are relatively small, generally varying between 0.01 and 1 ha in size with an average depth of 1 m. They should have a good water supply, a regularly sloping bottom ensuring complete drainage and an adequate water-level controlling structure at the outlet. Good road access to all ponds is also essential. Pond outlets can be either monks or sluices. A monk structure may be built to control the rate of draining of the pond with a sluice system or valved.

Water level can be controlled by using two rows of planks (sluiced). The space between them should be filled with organic manure swelling in the water and closing water seepage. A screen on the top of a third row of planks prevents fish from escaping. Nursery ponds should be kept dry when they are not used, and should be prepared for the new breeding seasons by:

- (1) allowing the base to dry and should be cleaned.
- (2) quicklime should be dispersed over the pond bottom at an average rate of 150 kg/ha.
- (3) Manure (organic fertilizer) should then be distributed at an average rate of about 3–5 tonnes/ha to ensure the growth of natural fish food organisms such as phytoplankton.

Nursery ponds should be freshly filled with water. Care should be taken to avoid the entrance of invasive fish species. Filtering water is done through a frame covered with fine mesh placed into a filtering box; or a densely woven basket. Monks with three rows of planks allow taking water from the surface or from the bottom. Fertilization of small nursery ponds (max. 400 m<sup>2</sup>), can be done with inorganic fertilization from the banks. In larger ponds, it is done from a boat.

#### The doses are:

- 150 kg/ha ammonium nitrate (43% nitrate nitrogen) when the pond is half full.
- 100 kg/ha superphosphate fertilizer (18% active ingredient) when the pond is full. Old ponds with a high mud content do not need phosphoric fertilizer, as the mud is full of precipitated phosphorus compounds.

## Module 4: Hatchery Design and Management

Chemical preparation of nursery ponds will result in various groups of zooplankton. As explained earlier, relative abundance (1) and dominant groups of zooplankton and phytoplankton vary with time (2) starting from pond filling, first, rotifer population develops. This is immediately followed by small cladocerans. Later, larger cladocerans and copepods dominate in the zooplankton. The mouth size of the developing fry determines which groups of zooplankton can be consumed. First, rotifers and, later, larger members of the zooplankton are consumed. For the above-mentioned reason, the objective of a biological preparation of nursery ponds is to ensure a dense population of those members of zooplankton that are most suitable as a first natural food for stocked feeding larvae. **There are two options:**

Always check the quality and zooplankton content of the source water that fills the nursery pond. After filling, fertilization and chemical preparation of a nursery pond, it is important to check the quality and quantity of zooplankton. It should be done as follows:

- 100 L of pond water should be screened through a 120–180 micron mesh-size plankton net.
- The sample should be sedimented by adding 1–2 drops of formalin to it. Providing the result is satisfactory when the zooplankton (mainly rotifers) is about 2–3 ml/100L of pond water.

Stocking of feeding larvae occurs when the pond water is ready and full of rotifers. The feeding larvae can be transported from hatchery to the ponds by various means:

- (1) Close to the hatchery, a 30L plastic container serves well for the purpose.
- (2) For longer distances, a small tractor/trailer.
- (3) Small trucks or lorries are used, equipped with oxygen supply.

To avoid heat shock, it is necessary to ensure that the water temperature in the transport containers does not differ by more than 1–2 °C from that of the pond water. To equalize the temperature, pond water should gradually be added to the transport water. It is advised in order to increase the population of plankton crustaceans in advanced fry rearing ponds, they should be inoculated with zooplankton collected from another pond. It should be done as follows:

- About 4–5 days after stocking feeding larvae into a rearing pond, plankton crustaceans should be collected from other ponds with a zooplankton net and transported either in buckets or in a tank.
- In small nursery ponds (100–400 m<sup>2</sup>), a living biomass of about 100–200 ml (one full bucket of dense zooplankton population) is required.
- In larger nursery ponds, about 1000 ml (4–5 buckets of dense zooplankton population) is required. This zooplankton will rapidly reproduce and boost the resident population in well-fertilized ponds.

## Module 4: Hatchery Design and Management

Growth, survival rate and health of growing fry should be checked regularly. Fry can be observed directly in the pond using a white plate as background. They may also be fished along banks and in grassy areas with a fine-mesh dip net. Swimming behaviour together with their general conditions can be observed in a glass. Presence of ectoparasites can be detected with a binocular microscope.

At harvest, the water level should slowly be reduced by half-drained ponds. Fishing starts with a fine-mesh seine net. When most fry have been removed, the water depth is further reduced and fish are trapped at the outlet. During the operation, a long fine-mesh screen is slid into the outlet structure. At the end of the harvest, this screen is replaced by a trap.

### Tank Production

Breeding stock are housed in a 1:3 male to female ratio. During the early 2000's, sex reversal or masculinization technology was common placed in Tilapia production using 17 alpha methyl testosterone. This was applied to day old fry via powered feed until 28 days of age. Genetically, male fish were unaffected as the feed was high in protein as well. Genetically, female fish did not develop ovaries so all fish displayed male traits of rapid body growth (Mohammed and Ramnarine 2014). Within the last decade however, supermale technology has displaced masculinization. Super male technology produces all male fry and fingerlings (**See Figure 13**). Once the males fertilize the eggs, the females hold these in her mouth (same occurs in happa production of fry in ponds). The eggs can then be retrieved and placed in a hatching jar. Once the fry are hatched, they can be housed in a clear water tank until the yolk sac is absorbed before moving them to a green water tank.

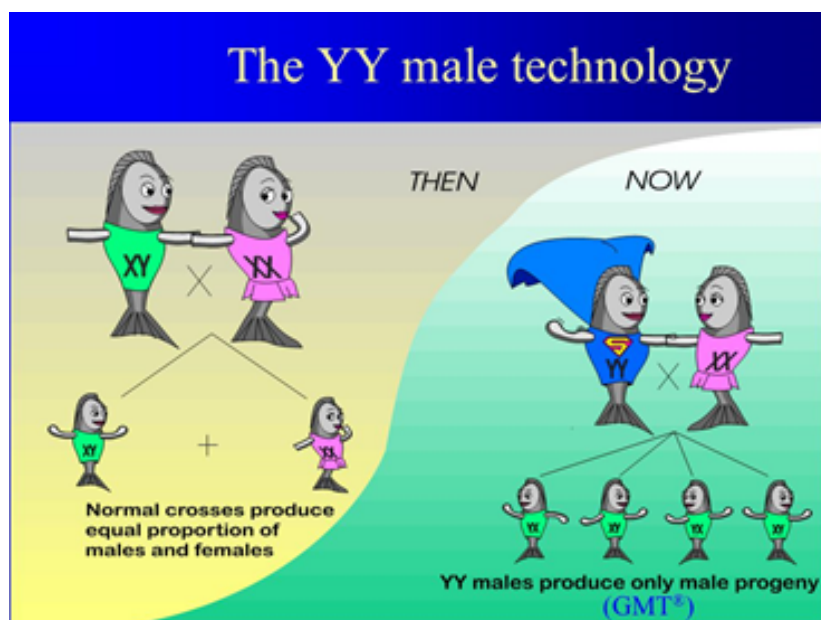

Figure 13: Supermale brood stock - all male fry production

Whether super male technology is used or masculinization, it has been shown that green water hatcheries have better production, as there is higher fecundity, lower mortality, faster growth rate.

# MODULE 5

---

## Grow-Out Management

### Goal

The purpose of this module is to teach trainees about the various elements of management of a grow-out facility, regardless of species of culture.

### Learning Objectives

**At the end of this module trainees should be able to:**

- ▶ Understand the importance of and implement feed management.
- ▶ Understand the different types of infrastructure and maintenance of these in a grow-out facility.
- ▶ Understand the importance of weight monitoring of stock at a grow-out facility.



# Introduction

No two grow-out facilities are ever identical, regardless of system type, species or location environment, as weather and other local conditions (even within a greenhouse or warehouse) are never identical. With this in mind there are still some basic principles that are common to all facilities. These include nutrient input (feed) and how this is managed, maintenance of infrastructure such as plumbing and filtration and lastly weight monitoring of stock.

The latter is very important and usually not considered by several farmers, as they tend to assume they know the best time to harvest stock. This can lead to reduced profits as weight gain rate by several species, plateaus even though they continue to grow. It is imperative these stocks are harvested, as feed is not wasted by simply maintaining the fish in holding tanks.



### Feeding and Feed Management

Providing farmers with nutritionally balanced feeds is a prerequisite to cost-effective production. Formulation issues, in particular the provision of species-specific feeds that address the nutritional requirements of the different life stages of the farmed animal (larval, fry, grower, finisher and broodstock) remain issues for both commercial and farm-made feed production sectors. Many of the commercially manufactured formulations that are available to farmers are based on laboratory formulations using high-quality ingredients; few are conducted under commercial farming conditions.

Formulations based solely on laboratory experiments do not always translate well to commercial conditions, where lower quality feed ingredients and least-cost formulae are applied. Likewise, the formulations are not always supported by rigorous scientific research, are poorly formulated, and sold to farmers who may be unaware of the nutritional requirements of their farmed species. In some instances, farmers were being encouraged to use the same commercial formulation for multiples species, which have different nutritional requirements.

(adapted from Hasan and New, 2013).

The use of poorly formulated feeds that fail to satisfy the nutritional requirements of the species and their various life stages, will inevitably result in feed inefficiencies and raised production costs. Evidently, there is a need to inform farmers, feed suppliers and unregulated feed manufacturers of the importance of selecting and supplying appropriate species and size-specific formulations.

While a significant amount of research has been undertaken to establish the nutritional requirements of many of the species groups, much of this has not been communicated to the farmers producing farm-made feeds or to small-scale feed manufacturers. Evidently, many farmers producing farm-made feeds are often unaware of the nutrient requirements of their farmed species, notably dietary protein and energy levels and how these change over the production cycle. Formulations are often based on past experience (what the farmers themselves have found to work), feed ingredient availability and cost, and advice from other farmers and feed ingredient suppliers.

While farmers generally recognize the need to use quality feed ingredients, they often appear unaware that feed processing has a significant effect on feed quality and utilization. Presenting feeds as simple dry or moist mixtures or as moist mixed feeds, lead to much of the feed being dispersed in the water column, resulting in low ingestion rates and high economic feed conversion ratios (eFCR). Ideally, farmers strive for a 1:1 eFCR which equates to 1kg of feed is needed to produce a 1kg of harvested fish. In most scenarios, more than 1kg of feed is needed, however the feed and management of the feed program becomes increasingly important.

## Module 5: Grow-Out Management

Feed efficiencies can be improved by encouraging farmers to use simple extruders and compressing their feed ingredients into dry pellets. Likewise, improving milling and the binding characteristics of the pellets, reduces the amount of fines, improves pellet hardness and water stability, improves eFCR, and results in cost savings to the farmer (Rana et al, 2013).

For most clear water systems, a complete feed ration, providing the complete nutritional compliment for the production species is required. It is important to re-emphasize nutritional compliment of species vary. Production systems that include green water can have relatively high productivity with a supplemental feed ration, providing the species such as Tilapia are either omnivorous or herbivorous. Feed is most efficiently applied to production systems considering the total stocking weight within an enclosure. Feed should be applied at a rate equating 10% of the total weight of the fish, stocked within the enclosure per day. This 10% total could be broken up into twice, three or four times feeding totaling the 10% feed per day.

The feeding regime should be adjusted weekly, taking a subset of the fish from the enclosure and determining the average weight and multiplying this average weight of the sub-set of fish by the total number of fish in the enclosure to determine the total biomass. This therefore means the weekly mortality of fish per enclosure records, must be kept along with the initial stocking amount of fish. In pond systems, this can be a challenge as dead fish might not always float making keeping track of mortality difficult. Predation by birds and caiman pose another challenge, as biomass leaving the enclosure might not be accounted for. In this light, tank systems are more manageable.

Additionally, extruded feeds are needed for some species. These extruded feeds float and are best suited for species such as Tilapia and snappers that are willing to surface feed. Other species such as catfish and shrimp require a sinking or non-extruded feed, as these species are benthic or bottom feeders. It is important to note, some feed have a relatively short timeframe in which the pellets maintain their integrity. In such cases where the feed disintegrates before consumption, it can lead to clogged filters and or ammonia spikes contributing to poor water quality. Additionally, this can lead to reduced profit as money is wasted on feed not consumed. Feeding management for hatchery systems are usually more precise and was discussed in **Module 4** (Hatchery Management).





There is great importance of applying appropriate feed transport, handling and storage techniques. Imported commercial diets are particularly vulnerable to spoilage during shipping because sea freight storage conditions are sometimes suboptimal and, depending on the route, delivery times can be significant. Likewise, transporting feeds in open trucks, motorbikes and bicycles can also result in long transit times and, on poor roads, this can result in the pellets being damaged. Feed should always be kept dry and cool. Vermin such as rats, weevils and ants should also be avoided.

Food habits could be a factor determining the fish species to farm. Under specific conditions, if the goal is to provide food fish for a population suffering from hunger, fish that feed low on the food chain could be selected (low-cost protein). On the other hand, fish that feed high on the food chain could be selected (high-cost protein) if the fish farmer is profit-oriented and consumers can afford the fish price. Feeding a low-cost protein fish as forage (feed) to a predator fish species is usually uneconomical. It could be economical if the feed fish is very cheap, eg. caught in the wild, and is provided as feed to a high-value fish species.

The more resistant a fish species is to poor water quality, the more feed per unit area per day can be fed without causing fish mortality. The more feed fed per unit area per day, the higher will be the carrying capacity. **Table 5** shows the typical feeding rate for pond and tank grown tilapia.

**Table 5: Feeding Rate in comparison to wet mass of tilapia**

Fish Wet Mass (g)	Feeding Rate (% Body Mass/Day)
0-1.0	30-15
1.0-5.0	15-10
5.0- 25.0	10-5.0
25.0-150.0	5
150.0-250.0	3
250.0-450.0	3

### Facility and Equipment Maintenance

In pond systems, digging tools are very important. Most of the maintenance and repair works in fish farms are devoted to dikes. Practically, the same implements in manual construction work are also being used in making repairs of dikes. Digging tools, flatboats, wooden dugouts and rafts as previously mentioned, are most appropriate for work like digging out trenches and backfilling them with puddled soil to repair leakage/seepage, and for deepening canals and other similar jobs. Maintenance of digging tools are easily done by cleaning and rubbing with oil or grease to prevent them from rusting. Similarly, levelling tools are important for pond bank maintenance and water flow. Practical and simple equipment have also been devised for levelling fishpond bottoms. (adapted from de la Cruz, 1983).

Water and soil analysis kits are now available in the market. For coastal fish farms, a set that could monitor dissolved oxygen, salinity, pH, are most essential. Additional useful observations involve nutrient-content (N-P-K), depth of visibility (turbidity), etc. Simple visibility observations can be done using the Secchi disc. Direct salinity readings using refractometers are easy to do but the equipment is quite expensive. Improvised hydrometers may be used after standardizing them with a salinometer (hydrometer) or refractometer. It is advised small scale commercial fish farms utilize at least water quality test strips (APC ©) and larger scaled facilities should invest in La Motts water quality test kits. For repeated monitoring a YSI © Multiprobe digital unit can be used to test a range of parameters such as pH, Salinity, Conductivity, Total Ammonia, Chlorine ions, temperature and dissolved oxygen concentrations, all of which are worthy of testing in tank-based systems which usually carry a higher stocking density of fish.

Similarly, in tank systems, plumbing for aeration and water flow requires continuous monitoring and maintenance. Whilst air blower and aerator seldom go bad, they do require cleaning to prevent the build up of dust at the intake vents. This can lead to clogging and overheating if not maintained which can lead to subsequent loss of efficiency and increased electricity consumption or even worse, burnt out air blowers. The output line from air blowers are usually very hot, monitoring of these for small cracks and leaks is also recommended as this will also lead to decreased productivity.

Tank systems also utilize filtration systems. These should be checked daily and a maintenance schedule be implemented for routine cleaning to prevent clogging and overflowing of the system. The slush from these filters are rich in nitrogen and should be used as field crop fertilizers. These run a lower risk of osmotic burning of plants, as the slush has a low concentration of Nitrogen.

### Wet Mass Monitoring

The importance of weight (wet mass) monitoring has been emphasized in the section above on feed management. Again, the weight of fish stock directly impacts on feed consumption. Regular weight monitoring also informs the farmer so the growth plot can be determined. In most systems for example with tilapia, fingerlings are stocked at 2 grams or 0.07 ounce.

Within six months they should attain a minimum harvest weight of 0.5kg to 0.75kg (1 to 1.5lbs) (See **Table 6** for growth rate). For different species these stocking weights differ, as well as the harvest weights. It is important to note the weekly checking of the stock informs the farmer of early problems regarding growth and shape of fish for example, elongated fish might show signs of poor nutrient uptake.

Consistent monitoring will also allow the faster growing fish and slower growing fish to be separated (runts). This will reduce aggression within the enclosure so small fish can be allowed to feed and the larger fish which will then be housed together, can be ready for sale at an earlier date. Weight monitoring therefore allows the farmer to predict when fish sales for both retail and wholesale can be organized, as putting logistics in place for scheduled harvesting is of optimal importance.

**Table 6:** Tilapia mass (starting at Week 0 at fingerling stage). This is the mean growth rate for tilapia using data from pond, tank and aquaponics systems

Weeks	Mean Body Mass (g)	±
0	5.5	0.5
4	24.4	5
8	65.4	10
12	113.6	20
16	157.4	30
20	195.9	35
24	243.5	45
28	273	50
32	312.8	55
36	338.1	60
40	343.8	65
44	400	75
48	433	85



### Goal

The purpose of this module is to provide trainees with the appropriate methods of harvesting stock, processing and the considerations for a value-added product.

### Learning Objectives

**At the end of this module trainees should be able to:**

- ▶ Understand the methods of harvesting stock from enclosures.
- ▶ Know the different options of processing a fish for market.
- ▶ Know the options available for a value-added product and considerations in the value chain.



# Introduction

In this module, criteria for harvesting will be elaborated as well as the procedures for harvesting inclusive of pre-harvesting. In the situation where further processing is an option, post harvesting guidelines will also be explained.

When growth is density dependent, partial harvest of the standing stock of cultured species (fish or shrimp) over the course of the growing season (i.e., partial harvesting) would decrease competition and thereby increase individual growth rates and total yield. Existing studies in optimal harvest management of aquaculture operations, however, have not provided a rigorous framework for determining “discrete” partial harvesting (i.e. partially harvest the cultured species at several discrete points until the final harvest).

Marketing options will also be considered, as well as post processing waste issues to be considered and managed to reduce negative environmental impacts. The supply chain for fish at the aquaculture site, and it ends with the consumer, who can be in the same country or in another country. The supply chain links a network of harvesters, retailers, distributors, transporters, storage facilities and suppliers that all work together to produce, deliver and sell a product to the consumer. A fisheries value chain describes how value is added to the fish, as it moves through the system to the consumer. This can be done, for example, by processing the fish into dried, smoked or any other type of processed product.

Fish supply and value chains are affected by many factors: product demand, available processing materials, regulations, access to markets and competition. Climate change and natural disasters can also affect the supply and value chain of fish. It is therefore important to understand the different linkages and to consider how fishers and producers can react and adapt to fluctuations in fish supply and changing marketing environments.



### Gear Type and Options

The industry has designed various types of nets for use in fishpond operations. The fingerling seine, which is used for catching juvenile tilapia and shrimps, is a fine-meshed rectangular net, about two to four meters long by one meter wide. It is supported by two poles at both ends with floats of wood, rubber or synthetic material on the upper side and sinkers of lead on the opposite side.

A fingerling suspension net is usually a standard equipment in brackish water fish farms. This is a rectangular or square net 2 to 3 meters wide by 3 to 5 m long. Double line of coarse twine line the margins, the net has mesh of 0.5 to 1.0 cm square mesh. It is used to hold fingerlings during counting or before transport. The latter net is commonly used in coastal Guyana facilities. The cast net is also commonly used in Trinidad and Guyana. This is a versatile net for fishermen, as well as for fish farmers for small-scale individual catching or sampling. In fish farms, this net can be used for sampling stock of fish or shrimp to monitor growth or for partial harvesting when required.

#### **Apart from suitable nets other gear and equipment include:**

- Transfer buckets
- Landing nets
- Ice coolers and ice scoop
- Ice
- Aerated purge tank
- Protective gear such as gloves and boots

Once an enclosure has been identified for harvesting, it should be determined if it would be a complete harvest of all individuals or a partial harvest. Ideally, larger fish should be sold first. In the case of partial harvest and if the enclosure is a pond, only some of the water might be required to be drained. If this can be stored, it would be beneficial. This would be discussed in the module on Water Budgeting.

A partial pond harvest would require the pond to be harvested via seine (using a minimum of two persons) and the larger fish placed in buckets for purging. The same can be done for tank systems. A complete harvest might involve the same procedure, however more storage and transfer buckets would be needed. Sorting of fish should occur during the harvest process.

The purging process is recommended for all fish and crustacean species. In tank systems this could occur simply by isolating the flow of the individual tank and doing a 100% water change. The fish would only need to be at 75% the total volume of water. From here on the fish would not be fed for 24hrs to 48hrs to allow muscle toxins to be leached out of the flesh and similarly allow the gut to be cleared. This would also be beneficial during the post-harvest phase, as the gut will be cleared. For pond systems, the fish would be removed and placed in an isolated aerated tank with clean water. The fish should maintain a stocking density of one fish per cubic foot or 1kg per cubic foot.

If the purge tank is not located near the pond system, an adequate transport system needs to be in place to not stress the fish, which can also lead to death and loss of profits.

### Processing

#### i. Humane killing

Finfish and shellfish should be killed prior to slaughtering and processing and not during. Apart from the human and animal welfare issues associated with killing fish using inappropriate measures, this also releases stress hormones in the flesh which could affect quality. Killing should be done using a one to one per volume ice to water slurry. This process slows the heart rate and the organism dies during the sleep. The freshness is also maintained. The carcass must however, be bled to maintain flesh quality.

#### ii. Dressing of the product

Shellfish can be sold frozen or par boiled and packaged. Finfish have great versatility in their dressing and processing. A whole fish is seldom sold unless it is a fresh product at farm gate. Other than that, a dressed fish is sold. This can be as follows:

**Sliced:** head (split or whole), body sliced and tail packaged, with or without tail but other fins removed along with gut, scales and gills.

**Pan-dressed:** In this case the fish is regarded as 'whole' with the fins, gills, gut removed. Sometimes the head and tail are also removed or sold attached.

**Filletted:** Fillets are prepared by removing the muscle from either side of the finfish. The fillets can be prepared with the skin on or off. Pin bones (ribs) should also be removed.



### Processing Options - Value Added Products

Fish caught from good quality water is usually clean and the flesh is safe for consumption. Problems occur when rough or unhygienic handling, or bad control of time/temperature allow for contamination. Fish refrigeration involves either icing (which can be done in containers with ice), or through cool air circulating around the fish. Freezing fish tends to be a very expensive technique that uses a lot of energy. However, it best preserves the nutritional value and extends the storage life of the product. Ice glazing is sometimes done prior to freezing by spraying with water before placing within the freezing unit. (adapted from FAO 2015).

**Table 7: Storage time during refrigeration**

Fish product	Storage life in months		
	-18 ° C	-24 ° C	-30 ° C
Fat fish glazed	5	9	> 12
Lean fish fillets	9	12	24

#### I. Dry Salting

Dry salting is a technique that allows for the juices of the fish to be extracted. It can be done just about anywhere but the fish should not be spread out on the ground directly but on aired racks to dry. Layers of fish must be separated by layers of salt. This method is inexpensive, requires no energy source, increases the shelf-life and maintains a reasonable nutritional value.

### II. Smoking

When preserving fish through smoking, the actual process is the withdrawal of moisture or drying. Smoking is one of the oldest preservation methods in combination with other techniques such as salting and drying. Smoking exposes the food to smoke and heat in a controlled environment. A variety of elements are released during smoking. Some of these act as preservatives, some add flavour, while others can be toxic to people and may have health effects. The temperature used for smoking is an important variable, and lower temperatures are better, as long as they are hot enough to preserve the fish before the flesh starts to deteriorate. It is important to be aware that smoking requires large amounts of wood and can contribute to deforestation. Smoking of fish is often done in ovens that are walled in to increase efficiency.

However, this makes the working environment difficult and unhealthy for the smokers themselves. Some more modern ovens have been developed, the first among them is called the Chorkor oven (CTA 2010). It is fuel-efficient and safe for the smoker. The Chorkor consists of a combustion chamber and a smoking unit with a set of trays (**Figure 14**). The combustion chamber is rectangular and usually made of mud that has stoke holes for a fuelwood inlet and fire control. A set of 5-15 trays can fit depending on the fish to be smoked and the trays are made of wood with wire mesh.

**Figure 14:** The Chorkor Oven fo smoking fish (FAO, CTA 2010)

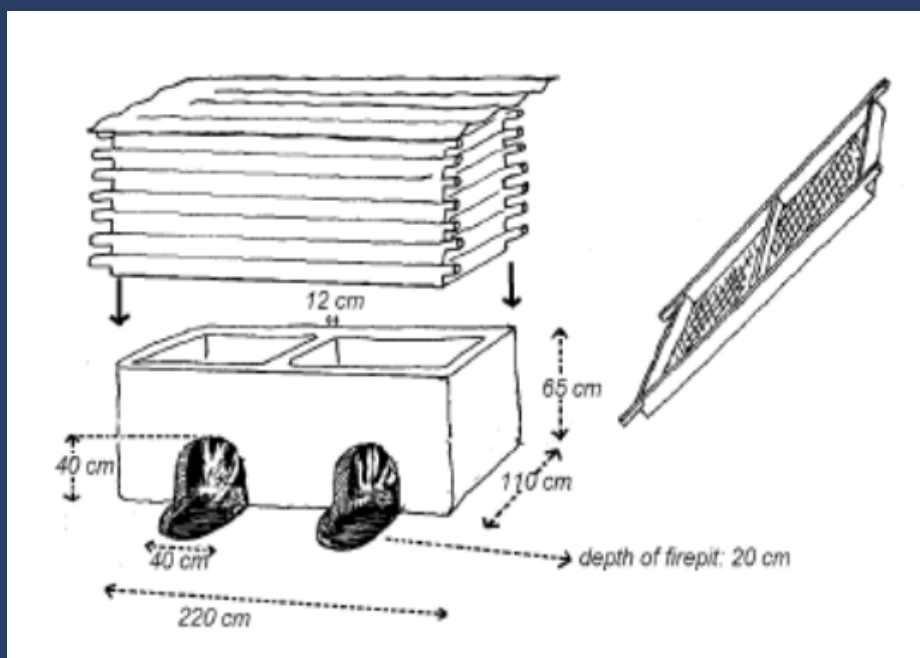

### III. Fermenting

Fermenting fish is another way of processing and preserving fish by encouraging beneficial bacteria to grow. In this particular method, the development of a distinctive flavour is both the result and principal objective. Fermentation is often combined with salting and/or drying because fermentation often results in the softening and breakdown of the fish muscle. The final product is often used as a condiment or in the preparation of sauces.

### IV. Fish Canning

Fish canning is a relatively modern technique of processing fish. Fish are sealed in a storage container for long periods – from a few months up to several years. The fish is usually headed, gutted, cleaned and trimmed, and then pre-processed either through salting, brining, drying, smoking, cooking or a combination of these. Vacuum sealing is another method of packaging fish that has already been processed in some other manner. In this method, all the air is removed from the package prior to sealing, thereby extending the shelf-life.

### V. Cooking

Cooking provides a short-term preservation. There are a variety of methods used to cook fish. Basic methods include boiling or poaching in which the fish is cooked in hot water. Frying fish uses hot oil. Other methods include baking, breading, etc. Generally, cooked fish products should be consumed immediately. However, by utilizing some of the packaging techniques mentioned above, the shelf-life can be extended.

## Challenges and Concerns During Processing

Changing weather patterns affect fish processing, especially fish drying. This is especially true for places where fish is sun-dried. Because of changes in climate, it can now rain in months when it never did, and be sunny in months that used to be the rainy months (unpredictable weather patterns). In some areas, there are no longer pronounced rainy or dry seasons. Changing weather patterns can also reduce the amount of fish available for processing.

In many countries, women are in charge of the processing of fish, and in some communities, it is the main economic activity of women. In many instances, they are also responsible for marketing the fish and are the financiers of the fishers. There are efforts to develop and promote drying systems using renewable energy in order to control the drying operation.

## Module 6: Stock Harvesting and Processing

Planning is important to reduce vulnerabilities. A Hazard Analysis and Critical Control Points (HACCP) plan can help to reduce the vulnerability in processing. To conduct a hazard analysis, it is necessary to analyse the food supply chain needs to determine where biological, chemical and physical hazards may occur. Then, critical control points (CCPs) need to be identified as the last controllable points within the chain where those food safety hazards can be prevented. For these points, critical limits need to be established (e.g. max./min. time and temperature) that the CCPs must meet to prevent/reduce hazard.

The entire system needs to be monitored with procedures using proper tools that alert you to food safety problems when critical limits are met. If this occurs, predetermined corrective actions need to be taken. All of this should also be documented to provide evidence that food is handled and prepared safely. The plan also needs to be regularly verified to confirm CCPs/ limits are appropriate and monitoring/corrective actions are adequate. The HACCP system is not only for processing sites. Even a fish trader can have a simple HACCP plan, as can a fisher or a fish farmer.

Sometimes, children can be involved in the fish value chain. If the tasks they carry out prevent them from attending school or harm their health and development, this is considered child labour, which is not acceptable. There are international standards developed by the International Labour Organization to protect children and eliminate child labour.

### Supply Chain and Value Chain

#### I. Supply Chain

The supply chain includes all links from the point of production to the end user or final consumer. The supply chain for fish and fishery products can involve a large number of people between the fisher or fish farmer and the final consumer. The supply side of fish and fishery products is affected by factors such as: market demand, prices, seasonality, climatic conditions, population dynamics, economic situation, fuel prices, policy and legal environment.

The perishable nature of fish requires special attention to handling, grading and packing, and the market price is usually dependent upon the quality of fish (although this is not always true when demand does not match supply). Supply chains are concerned with how long it takes to present the good for sale. The main objectives of supply chain management are to reduce the number of links and to reduce bottlenecks, costs incurred, time to market, etc. Good supply chain management is essential to develop a value chain.

### II. Value Chain

A value chain is a supply chain where at every stage value is added, as the product moves from production or the landing site to consumption. The product gains value, for example, through processing or packaging. Value chains are concerned with what the market will pay for a good or service offered for sale. Market considerations differ from country to country, region to region and have close connections with food habits and consumption patterns. The main objectives of value chain management are to maximize profit and long-term sustainability.

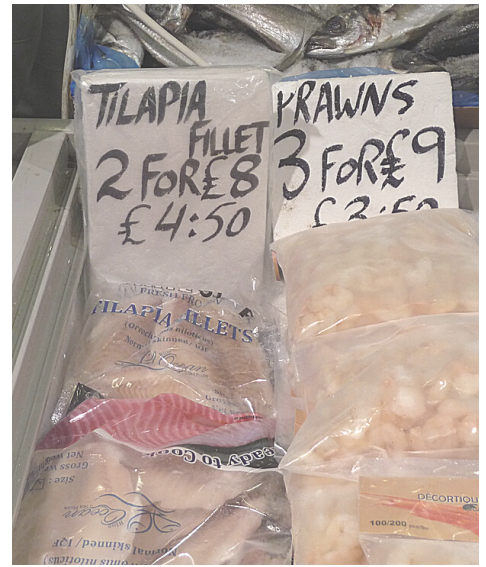

### Silage Production from Offal (processing waste)

During fish processing, a large quantity of offal is produced and its proper utilization poses a problem, particularly for smaller processing plants. Fishmeal production is not profitable because of a low supply of the raw material, and thus production of a liquid form of this fish product is the only simple solution.

Production of fish hydrolysate (silage) to be used as feed is the cheapest way of utilizing offal. Considering the capital needed and the operating costs for fishmeal and hydrolysate production (cost ratio 4:1), production of the liquid form of this by-product is very profitable and it can be done by small plants. It is a simple technological process, but several rules must be observed to obtain a satisfactory final product.

The raw material, the offal, must be fresh; decomposing offal should not be processed. The main phases of offal processing are: grinding of offal or whole fish, acidifying of the pulp and liquefying it which results from a self-digestion (autolysis) process. Adequate grinding is a basic operation of the process.



### The following preservatives are used to produce pyrosilage:

- sodium pyrosulphite ( $\text{Na}_2\text{S}_2\text{O}_5$ ), 1% for fatty and medium fatty offal, and 1.3% for lean product.
- sulphuric or hydrochloric acid, both at 1% concentration in the mix.
- The measured pH should always be the final indicator of a proper level of acidification and should range from 3.5 to 4.5. The pH should never exceed 4.5.

### A production cycle consists of the following stages:

1. Grinding of the raw product in a grinder.
2. Loading of circa 100 L of ground product from the dispenser into the mixer drum, and adding 1.6-2.0 l of sulphuric acid at density 1.28-1.3.
3. Mixing for about 10 minutes and adding a solution of sodium pyrosulphite (1 kg of pyrosulphite dissolved in 3-4 L of water).
4. Additional mixing for 5 - 7 minutes and pouring of the product from the mixer drum straight into the 120 L barrels.

An approximate chemical composition of fish silage is protein - about 15% fat, 6-14% (depending on raw material), ash - 2.4%, micro-elements and vitamins.



# MODULE 7

---

## Water Budgeting and Production Waste Management

### Goals

The purpose of this module is to teach the trainees about the importance of water reserves and methods to manage wastewater from production systems. The trainees should have an appreciation for water and waste monitoring at the facility to minimize negative impacts to the environment.

### Learning Objectives

**At the end of this module trainees should be able to:**

- ▶ Understand water conservation and water reserves for aquaculture systems.
- ▶ Implement wastewater and effluent management from aquaculture facilities.



# Introduction

Given the major issue of overall rainfall reduction in the Caribbean, as well as harsh hurricane seasons where excess water occurs, the new aquaculture sector in the Caribbean will need to be better adapted to these conditions.

Additionally, the management of aquaculture waste as a resultant resource is of utmost importance. This module will consider the island's rainfall and also develop the skills for management of these resources.





### The Water Budget

Water budget can be defined as the relationship between the inflow and outflow of water through a specified region. A water budget is an accounting of the rates of water movement and the change in water storage in all or parts of the atmosphere, land surface, and subsurface. Although simple in concept, water budgets may be difficult to accurately determine. (adapted from Healy et al 2007).

For pond-based systems, it is advised farmers should design the farm layout to include one deep pond (in excess of 2m) for the storage of water. This would allow for emergency water changes and topping up of other grow-out ponds.

To reduce the potential for mosquitoes breeding, live bearers fish such as guppies can be added to feed on these larvae. These should not be fed as they would predate on the natural fauna in the pond. Additionally, feed could lead to a surplus of fish and an ammonia spike. Stored water should be at least 25% the total volume of all production water.

For tank-based systems, storage should also be at 25% capacity of all production water. Special allocated tanks should be placed in close proximity to the production facility. Most tank systems require water to be topped up weekly.

Farmers should keep a close eye on the depth of water in pond and tank systems and also note the volume of water to be topped up weekly. If the stored water reserves should fall below 10% at any point in time and there is no clear way forward to replenish this within a week, the facility is in need of additional water storage. Attention should also be paid to ponds, tanks and plumbing that might be leaking. Water loss in relation to weather conditions is usually a good indicator of leaking plumbing or ponds. It is also good practice to record daily weather conditions, ambient air temperature (same time of day) and water temperature of production enclosures. Farmers need to pay attention however to the local legislation, allowing for rainwater harvesting and tapping of water from the public grid.

### Excess Water Management

The Caribbean has been seeing an increase in frequency and intensity of storm activities within the last decade. As such, farms' designs need to be resilient to such stochastic events. The major threat in such situations would be wind and water damage. Apart from designing systems that can be secured at short notice to prevent failure of the plumbing and electricals, there is very little that can be done to secure a facility against storm conditions and gale force winds. Most tank farms are resistant to flooding conditions as they are raised. Ponds on the other hand should not simply be dug-out but also have an embankment above ground level to protect against flooding and water from outer regions from flowing in. Aquaculture facilities should have an embankment around its periphery, regardless of type of production system to protect against flood water damage to ponds, filters and electricals such as water pumps. Bilge, submersible and inline suction pumps are handy to keep in storage incase there is a need to rapidly pump water away from the facility.

### Water Conservation

Without water there can be no aquaculture. During excessive dry spells or islands with low incidence of rainfall, water storage becomes integral. Farmers need to ensure this stored water, (usually in tanks) does not become a breeding habitat for mosquitoes. These tanks should be sealed to prevent the access of insects. Rainwater harvesting from roofs' guttering and spouting can be channeled towards storage tanks.

Farms can also be oriented in such a way to allow surface run-off water to be channeled toward storage reservoirs. However, care should be taken with such a design, to prevent contaminated surface water from flowing into the reservoirs. Road access to the periphery of such reservoirs should be limited to avoid contamination by oil residues etc. The primary inflows are precipitation, runoff and regulated water additions. Reduction in effluent volume is the most effective water saving means, and not only reduces water consumption but also reduces the pollution potential of pond aquaculture.



### Waste Management

Ponds seldom need a complete water change during a production cycle. During harvesting it is easier to drain the ponds down. Waste water should be pumped into shallow troughs and grow beds where the water can be used for irrigation purposes. In areas where the water availability is an issue, the water could be reused if treated properly. In this scenario, the water can be placed in holding ponds with aquatic plants. The plants would remove the ammonia, and utilize this nutrient source. The plants could also be sold in the ornamental trade.



Tank based systems usually require cleaning of filters weekly at least along with 10% water change. Most facilities stagger this activity per tank or module, giving water tanks the chance to be topped up by either the national grid or rainfall. Additionally, with a 10% per tank outflow it becomes easier to manage the wastewater.

Both tank and pond facilities can be designed to allow for adjacent land area to be planted with field crops such as taro or dasheen. Dasheen (*Colocasia esculenta*) is a tropical plant grown primarily for its edible corms, a root vegetable (**Figure 15**). It is the most widely cultivated species of several plants in the family Araceae, that are used as vegetables for their corms, leaves, and petioles. Ornamental members are also possible to be cultivated.

The dasheen provides both a viable staple food crop with leave and corms being edible. The plants can be planted on raised beds among flooded drains. These will also utilize the nitrogen wastewater. Other local seasoning herbs can be planted on these raised soil beds providing multiple crops without the use of any artificial fertilizers (**See also Figure 2**).

The semi liquid slush that results from the cleaning of filter tanks can also be placed in the troughs that flow to the dasheen troughs. Care must be taken to not have stagnant wastewater pooling, as this would encourage a wide range of flies that can contaminate feed and also provide habitats for mosquitoes to breed. Farmers need to determine the total volume of water to be flushed out of the production system per day and pecculation time for the water to be flooded in the trough and be disseminated into the soil. By using the grow beds to utilize wastewater, zero waste water effluent will go into the public drainage system and not be a source of nitrifying pollution from aquaculture facilities.

Using either pond or tank water to irrigate field crops ensures zero direct effluents into the natural and public water ways. **This method of integrated farming has multiple benefits such as:**

- i. a wider variety of products
- ii. consistent supply of product as the farmer does not have to wait for the fish to be harvested to retrieve returns
- iii. feed cost for fish is off-set
- iv. no field fertilizer cost
- v. field crops can be marketed stating 'without the use of artificial fertilizer'
- vi. more environmentally friendly
- vii. easier to manage and set up than aquaponics systems

**Figure 15:**  
Dasheen, Taro (*Colocasia esculenta*).  
Source: [www.dreamstime20.com](http://www.dreamstime20.com)



### **Aquaponics - Limited Waste and Water**

Aquaponics systems were discussed at length earlier on. However, they do offer a unique method of production of plants and fish by controlling water usage. Water loss is minimal in such systems, but flow rate is imperative for the success of the system. Wastewater is also minimal as only sludge water from the clarifier which can total as little as 1% of the total production water, is the projected weekly loss.

This sludge water can be used on field crops as discussed above. Aquaculture systems do require storage water. It is recommended that stored water should be at least 25% the total production water. This is needed in case of emergency issues of ammonia spikes.



### Goals

The purpose of this module is to teach trainees about preliminary financial issues that need to be considered regarding stock and servicing of farm equipment, as well as smart aquacultural practices for building a sector.

### Learning Objectives

**At the end of this module trainees should be able to:**

- Understand the importance of financial and stock records.
- Understand the differences in infrastructure and pre-operating cost versus operating or production cost.
- Determining cash flow and returns on investment to determine profit and loss.
- Applying a sectoral SWOT analysis.



# Introduction

The magnitude of financial investment required to set-up, operate, and maintain an aquaculture operation depends on the level of technology involved and the type of culture system adopted. In general, the investment requirement increases as a function of technology level and degree of complexity of the culture system, with extensive systems requiring the least capital investment and intensive systems needing the most. It should be noted, insurance for such investment especially where there is a loan component, should be considered. Generally, aquaculture facilities are successful once adequate management procedures are implemented. This implementation of management directs several types of records to be kept.

**These include documentation of:**

- i. fish arrival as fingerlings
- ii. feed purchases and arrivals
- iii. weekly wet mass records of fish,
- iv. feed use inventory
- v. equipment inventory
- vi. weather conditions,
- vii. enclosure mortality
- viii. stock harvesting mass
- ix. fuel inventory (back-up generators)
- x. labour
- xi. brood stock pedigree to name a few

Record keeping determines the true cost and profits for any agriculture facility.

### **'Dollars and Sense' of Aquaculture**

Where investment costs are high and land and labour are limited and costly, the trend will be intensification to achieve maximum yields per unit area. Where land, labour and fish are inexpensive and feed is unavailable or costly, the trend is for extensive culture utilizing larger pond area and natural food. The costs incurred are usually two types: (1) Infrastructure and pre-operating cost and (2) Production and operating cost. A third cost (3) Developmental cost is typically a sectoral cost. During the development phase of the sector, the market acceptance is tested to determine species' acceptance, the best form or presentation of the processed product and packaging type. (adapted from FAO 2017).

#### **(1) Infrastructure and pre-operating cost**

As mentioned earlier, small-scale aquaculture development projects which involve simple production facilities (like rafts and stakes for mollusc culture and bamboos and ropes for seaweed farming) require minimal financial inputs. In contrast, highly intensive, highly complicated production systems, as those used for intensive shrimp grow-out operations, require large outlays not only for initial development but also for operation and maintenance.

The actual land or water surface acquisition is another large input cost at the beginning of such projects.

#### **(2) Production inputs and operating cost**

The major cost items in aquaculture production, as in any other type of agriculture: production inputs (seed stock, feed, fertilizers), and operating and maintenance costs (including cost of labour, power, supplies and materials), and miscellaneous expenses including harvesting and marketing costs.

Both costs can be managed and systems are designed knowing the intended market in mind. One should not invest in systems where it is unknown where the market for the product exists. The cost for processing and marketing needs to be considered, as many farmers also do their own farm gate sales and processing.

This marketing cost needs to include cost for transport of whole fish, ice, packaging, advertisement and distribution. In many instances where the product evolves to suit the intended market a developmental cost is also incurred as the general public sometimes needs to be sensitized about the locally produced product.

## Module 8: Budgeting and Cash Flow Management

Most production systems are not profitable until after their first two years. Systems usually earn returns after the first sale of product. However, the profit of this system is determined by subtracting the total cost of production or operating cost from the selling price. It is here the first gauge of profits are noted. Once successional profits from sales are noted this is totaled and then subtracted from the infrastructure cost to determine the debt of the investment. Again, most production systems realize their profitability only after the infrastructure debt is cleared which can take as much as two years.

During the production cycle, funds should be allocated for operating costs such as feed and labour. Feed cost contributes as much as 75% of cost of some production facilities. Some facilities fail not as a result of fish not growing but due to poorly managed funds. It is therefore imperative for the marketing to be secured and contracted as early as half-way into the production cycle.

Some farmer and farm managers stagger the production so all tanks or ponds are not harvested simultaneously. This allows for continuous inflow of cash into the farm, as well as allows for the stock in production enclosures to be selected for size. Putting fish in size classes has its advantages for feed and aggression management which translates into greater profitability.

Farmers should draft a time line with associated cost to predict cash flow. Time should always be allocated for legal and administrative approvals, as these could also affect the receiving of funds to start the sourcing of materials and commissioning of the farm.





### Risk Reduction and Sectoral SWOT Analysis

To be successful, you need to assess whether it is worth starting a business. For example, you have to ask if all the necessary inputs are available or accessible to run your business. What will it cost to produce your final product? Setting the price at the right level is very important. Can the price you want to sell it at cover the costs without being too expensive for the final buyer? Is there a final buyer who is interested in your product? Successful businesses will match the skills and resources of the entrepreneur or producer group with the needs of the customers. Who else produces a similar product and could be a competitor?

To work well over a long period, a business will have to learn to deal with risk, including competition and changing circumstances. One way of reducing risk is by linking with others to form a group. When people come together, they bring in different skills and resources and have more options to reduce risks.

A group also has a stronger voice in the market. Planning is key for the establishment of a successful business. The new business person should understand the environment they are entering with the business. A SWOT analysis is a tool that can be used to develop the business idea, make decisions, solve problems, and develop a marketing strategy.

A SWOT analysis comprises of firstly an idea or circumstance to be evaluated. Once this is determined, the following is identified:

**Strengths (S):** these are current benefits and reasons why the project should be implemented.

**Weaknesses (W):** these are reasons why the project should not be implemented.

**Opportunities (O):** these would be the forecastable favorable scenarios that should counter act the last element (T).

**Threats (T):** these could be current or foreseeable issues that might hinder the profitability of the project.

Once the sectoral dynamics are evaluated including the various bottle necks such as:

- Availability of reliable feed for both hatcheries and grow out
- Hatchery capacities- ensuring reliable fingerling stock
- Processing and marketing opportunities
- Financing and insurances
- Enabling legislation and government support

Other factors such as farm infrastructure can be designed, purchased and installed in preparation for a successful aquaculture sector.

### Insurances and Protection Measures

Most loan facilities will encourage an insurance component to aquaculture facilities. Aquaculture is still viewed as a high-risk investment within the Caribbean. The risk can be mitigated for by proper health and safety protocols, emergency response plans and infrastructure and equipment to maintain farm security. Nonetheless, financial insurance even though expensive should be considered especially for expensive farm equipment such as generators, solar equipment, aerators and water pumps. Other elements of risk should be considered and mitigated, for which could lead to reduced insurance premiums.

#### I. Personal and Bio-Security

Simple bio-security measures such as foot and wheel baths at farm gate entrances, reducing accessibility to production and enclosure tanks and sanitization of nets and other fish handling gear can maintain bio-security. This would protect staff and stock from communicable disease. Predation at pond facilities are sometimes an issue particularly by caimans, predatory fish and birds. Protection from flood waters help with controlling unwanted fish species and caimans, however birds and fish-eating bats might be controllable by using nets or security lines. These break-up flight paths and deter them, but is not 100% guaranteed. The use of security cameras can also help reduce losses by larceny and vandalism.

#### II. Emergency Response and Emergency Shut Down Protocols

During severe weather conditions, fires, floods or any other unforeseen circumstance an Emergency Response Plan or Emergency Facility Shut Down Protocol should be implemented. Shutting down of water pumps, aerators, generators are usually detrimental to farm stock, so only in extreme circumstances should this be considered. Protocols for these should be documented and the farm manager along with all staff should be fully cognizant of this.

In some instances, such as power loss, emergency power might have to be activated. It makes sense for farms to invest in back up power generation for water pumps and aerators. This is particularly important in aquaponic systems and recirculating tank systems that have a higher stocking density than pond systems. Generators should be switched on monthly to ensure proper working components. Fuel log should also be kept. Installation of automated generators with an automatic transfer switch (ATS) mechanism, usually needs permission from the national electrical authority, as well as generators above certain power capacities. Bunker storage of fuel also requires permission in several countries as this could pose a fire hazard.

# Conclusion

Aquaculture offers an alternative, healthy protein source for the Caribbean. This has the potential to reduce the harvest pressures of wild stock, while still providing a versatile compliment of species and products. Whilst the risk might still be considered high in some systems, farms should be designed taking their local conditions into consideration. Modular tank systems that re-invest the returns into farm expansion also reduce the risk and ensures continuous cash flow. It cannot be emphasized enough the importance of adequate record keeping at farm facilities.

It should also be noted, truly successful aquaculture facilities are not facilities that simply breed or grow-out stock. The science allows for several species to be cultured.

A truly successful facility is one that has a return on its investment and shows continuous cash flow by sale of products. It is imperative for markets to be determined before farm facilities are commissioned.

Farmers need to pay close attention to brood stock management to avoid the spread of disease among hatcheries. This will also avoid issues of inbreeding genetic depressions. Fry and juveniles also need to be closely monitored as the best aquaculture species such tilapia and Australian red claw crayfish are infamous aquatic alien invaders. This is primarily because most aquaculture species are good general feeders, hardy and resilient to high stocking densities. This therefore make them ideal for out competing native species. While farmers maintain bio-security to avoid pathogens and predators from invading their facilities, they also have a due diligence to prevent aquaculture species from escaping farms.

In light of this, a multi-species sector such as those seen in the far east, have proven to be successful. Waste management could potentially influence our profitability. An integrated approach to aquaculture will be able to offer increased food security to Caribbean states, as we can investigate further to produce a local staple carbohydrate source, further reducing the Caribbean's food import bill. With this in mind, by implementing green practices, aquaculture can find its place in the Caribbean's Blue Economy.



## References

- Adhikari, R., Rauniyar, S., Pokhrel, N., Wagle, A., Komai, T. and Paudel, S.R., 2020. Nitrogen recovery via aquaponics in Nepal: current status, prospects, and challenges. *SN Applied Sciences*.
- Assefa, W.W., Abebe, W.B. GIS modeling of potentially suitable sites for aquaculture development in the Lake Tana basin, Northwest Ethiopia. *Agric and Food Security* 7, 72 (2018). <https://doi.org/10.1186/s40066-018-0222-0>.
- Baluyut E.A. (1989). ADCP/REP/89/43 - Aquaculture Systems and Practices: A Selected Review. United Nations Development Programme (UNDP) Food And Agriculture Organization Of The United Nations (FAO).
- Cline D. 2019. Cage Culture. Auburn University Press. 10p.
- Coche A., and Edwards D. 1988. Selected Aspects Of Warmwater Fish Culture. FAO Press, 20p.
- De la Cruz 1983. Fish Pond Engineering: A technical Manual for Small and Medium Scale Coastal Fish Farms in South East Asia.
- FAO 2015. Post-harvest issues in fisheries and aquaculture Junior Farmer Field and Life School – Facilitator's guide. FAO Press. 50p.
- FAO 2017. Doing Aquaculture As A Business For Small- And Medium-Scale Farmers Practical Training Manual Module 1: The Technical Dimension Of Commercial Aquaculture. 53p.
- Hasan M.R. and New M.B. 2013. On-Farm feeding and feed management in aquaculture. FAO Press.
- Healy R.W., Winter T.C. LaBaugh J.W., and Franke O.L 2007. Water Budgets: Foundations for Effective Water-Resources and Environmental Management. USGS Press. 103p.
- Huet, M. and J.A. Timmermans, 1972. Textbook of fish culture. Breeding and cultivation of fish. London, Fishing News (Books) Ltd. 436 p.
- Khan M.D.G. 2001. Nursery system for carp species. FAO Press. 12p.
- Kungvankij K., Tiro L.B., Pudadera B.J, and Potesta I.O. 1985. Biology and Culture of Sea Bass (*Lates calcarifer*). FAO Press. 20p.
- Liao, I.C., 1988. East meets West: An Eastern perspective of aquaculture. Paper presented at the 19th Annual Meeting of the World Aquaculture Society, Honolulu, Hawaii, 4-8. 17 p.
- Meenakarn S. and Funge-Smith S. 1998 Small-Scale Fish Hatcheries for Lao. Provincial Aquaculture Development Project And Technical Services. FAO. 80p.
- Mohammed, R.S. and Ramnarine, I.W., 2014. Comparison between greenwater and clearwater hatchery systems during the masculinization process of silver tilapia, *Oreochromis niloticus* (Perciformes: Cichlidae). *Global Journal of Fisheries and Aquaculture*, 2(5), pp.177-181.
- Rabanal, H.R., 1988. Development of the aquaculture industry in Southeast Asia. In: Perspectives in Aquaculture Development in Southeast Asia and Japan: Contribution of the SEAFDEC Aquaculture Department. Proceedings of the Seminar on Aquaculture Development in Southeast Asia, Iloilo City, Philippines, 8-12 September 1987 (J.B. Juario and L.B. Benitez, eds.). 31-38.

## References

- Rakocy, J.E., Bailey, D.S., Shultz, R.C. and Thoman, E.S., 2004, September. Update on tilapia and vegetable production in the UVI aquaponic system. In New dimensions on farmed Tilapia: proceedings of the sixth international symposium on Tilapia in Aquaculture, held September (pp. 12-16).
- Rana, K.J., Siriwardena, S. and Hasan, M.R. 2009. Impact of rising feed ingredient prices on aquafeed and aquaculture production. FAO Fisheries and Aquaculture Technical Paper No. 541. Rome, FAO. 63 p.
- Somerville C., Moti C., Pantanella E. and Stankus A. 2014. Small-scale aquaponic food production Integrated fish and plant farming. Food And Agriculture Organization Of The United Nations Technical Paper 589. 124p.
- Technical Centre for Agricultural and Rural Cooperation (CTA), 2010. TECA - Technologies and Practices for Small Agricultural Producers. <http://www.fao.org/teca/new-search-result/technology-detail/en/?uid=6961>.
- Towers L. 2015. <https://thefishsite.com/articles/how-to-construct-a-semiintensive-pond-for-aquaculture>.

### **Caribbean WaterNet (Cap-Net UNDP)**

The mission of Caribbean WaterNet is to promote sustainable Integrated Water Resources Management (IWRM) in Small Island Developing States (SIDS) of the Caribbean: "Ensuring a future by learning in the present." Caribbean WaterNet focuses on building institutional and technical capacity of Caribbean SIDS as it relates to IWRM by increasing resilience of vulnerable populations across the region. It develops and administers training programmes, workshops, awareness initiatives and outreach concepts tailored to suit the Caribbean context.

**Website:** [www.caribbeanwater.net](http://www.caribbeanwater.net) | [www.cap-net.org](http://www.cap-net.org)

### **Faculty of Food and Agriculture, The University of the West Indies (UWI), St. Augustine**

The Faculty of Food and Agriculture (The UWI St. Augustine) focuses on agricultural progress, sustainable food production, improving food security in the region, increasing the environmental knowledge base of its members and thereby improving the quality of the lives of those touched by its work. With its relevant research and wide range of undergraduate and graduate offerings in agriculture, agribusiness, food and nutrition, geography and related areas, the Faculty is poised to make a significant contribution

**Website:** [www.sta.uwi.edu/ffa](http://www.sta.uwi.edu/ffa) | [www.sta.uwi.edu](http://www.sta.uwi.edu)

### **Global Water Partnership-Caribbean (GWP-C)**

"A Water Secure Caribbean" is the vision of the Global Water Partnership-Caribbean (GWP-C). It works to achieve this by supporting Caribbean countries in the sustainable development and management of their water resources by promoting Integrated Water Resources Management (IWRM). Together with its over 114 Partners in the Caribbean, GWP-C works with them to advocate, build capacity, communicate knowledge, build partnerships and mobilising multi-stakeholder groups to foster and sustain IWRM in the Caribbean.

**Website:** [www.gwp-caribbean.org](http://www.gwp-caribbean.org)

© Published in 2020 by Caribbean WaterNet (Cap-Net UNDP), The Faculty of Food and Agriculture of The University of the West Indies (UWI) St. Augustine Campus and with the Global Water Partnership-Caribbean (GWP-C).

